

L O N G T R A D I T I O N Y O U N G C R E A T I O N S

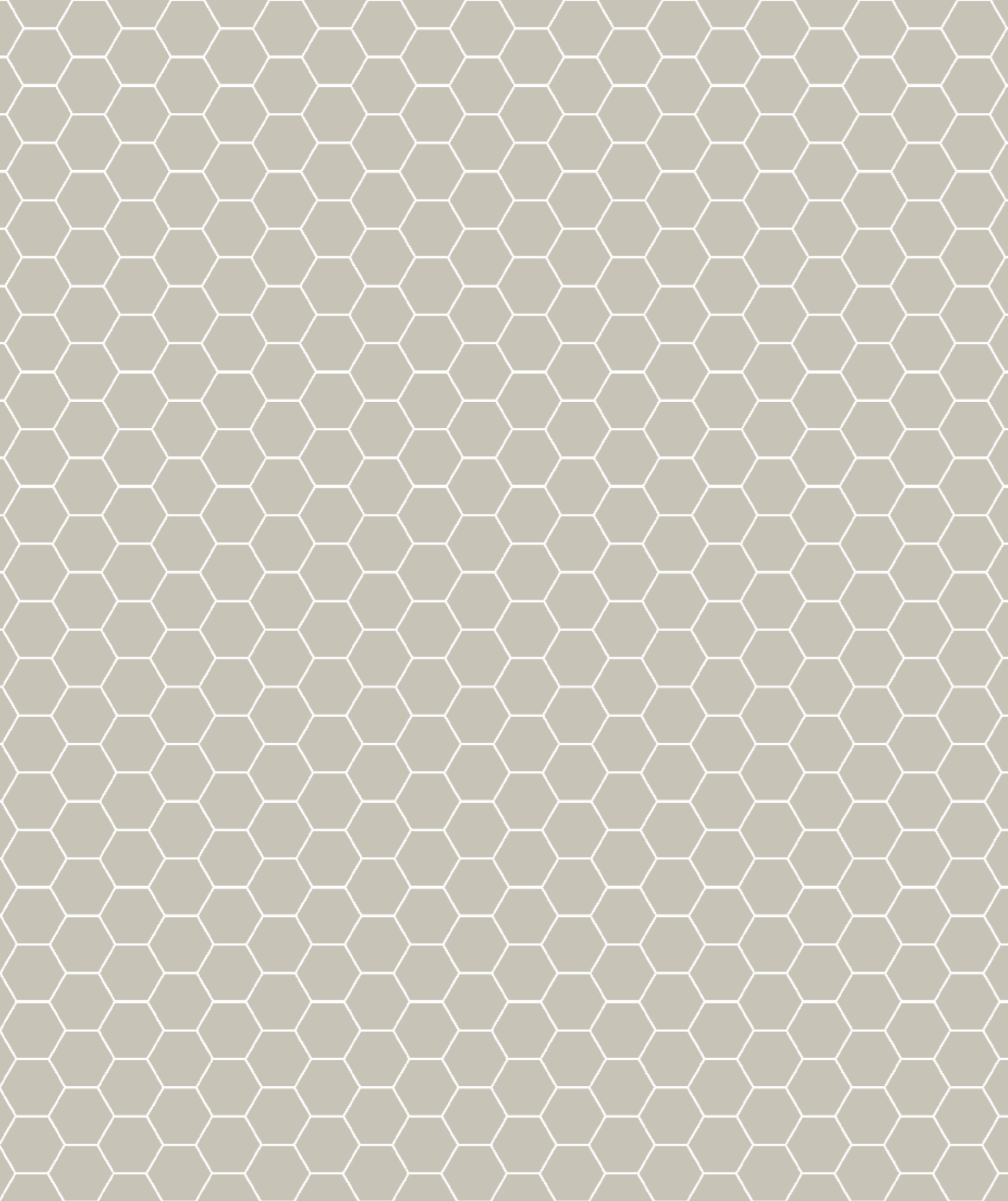

Il made in Italy è un prestigio antico basato sulla creatività che sposa qualità ed inventiva. Il made in Italy da sempre ci distingue nel mondo e valorizza la nostra maestria artigianale. Ogni creazione FDESIGN viene realizzata in Italia ed è l'espressione di una filosofia produttiva che vi garantisce la massima qualità sotto ogni aspetto. Garantiamo al cliente l'eccellenza nella scelta, manifattura e rifinitura delle materie prime, e l'impegno congiunto ad individuare, definire e sviluppare modelli capaci di esprimere l'eccellenza del made in Italy.

Made in Italy is an ancient prestige based on creativity combined with quality and inventive. Made FDESIGN creations are made in Italy and reflect our manufacturing philosophy, which guarantees you the highest quality down to the last. We provide the customer with a guarantee of the excellence of the selection, manufacture and finishing of the raw materials, with a mutual commitment to identify, define and develop models which could express the excellence of made in Italy.

MADE IN ITALY

# INDEX

## COLLEZIONI / COLLECTIONS

### MOTION

<u>AIDA</u>	8/15
<u>BENTLEY</u>	20/27
<u>CONCORD</u>	32/39
<u>DECOR</u>	44/47
<u>DRIADE</u>	58/59
<u>GAMMA</u>	40/43
<u>MATRIX</u>	28/31
<u>PARIS</u>	16/19
<u>PRISMA</u>	54/57
<u>SECRET</u>	48/53
<u>TRILUSSA</u>	60/63
<u>TRILUSSA LUX</u>	68/69
<u>TRILUSSA SLIM</u>	64/67

### FAST

<u>AGORÀ</u>	164/165
<u>HILTON</u>	166/169
<u>INGRID</u>	170/173
<u>LEVANTE</u>	188/189
<u>LUPIN</u>	182/183
<u>MICHELA</u>	178/181
<u>PLAZA</u>	184/187
<u>SPARTA</u>	174/177

### PREMIUM

<u>BAZAAR</u>	104/107
<u>GASSMAN</u>	72/79
<u>FASHION</u>	124/129
<u>LUGANO</u>	116/119
<u>MONZA</u>	108/113
<u>NATHAN</u>	88/93
<u>NILOS</u>	114/115
<u>OCEAN</u>	80/87
<u>ONDA</u>	130/133
<u>QUADRO</u>	100/103
<u>RUSSEL</u>	94/99
<u>TONIC</u>	120/123
<u>VOGUE</u>	134/137

### CLASSIC

<u>ALBATROS</u>	210/213
<u>DALÌ</u>	214/215
<u>DUSE</u>	218/219
<u>ELITE</u>	192/195
<u>EMPORIO</u>	196/199
<u>LUXOR</u>	204/207
<u>LUXOR MINI</u>	208/209
<u>ROYAL</u>	220/221
<u>VANITY</u>	200/203
<u>VIP</u>	216/217

### POLTRONE SINGLE CHAIRS

<u>BERGERE</u>	156/159
<u>DIVA</u>	150/151
<u>FLOR</u>	146/147
<u>GINGER</u>	152/155
<u>KALLAS</u>	142/145
<u>KRIS</u>	140/141
<u>LUXOR MINI</u>	160/161
<u>MEGAN</u>	148/149

### DIVANI LETTO SOFA BEDS

<u>AMALFI</u>	228/233
<u>BONUS</u>	264/265
<u>CIRO</u>	256/259
<u>HARRY</u>	260/263
<u>MAGNUM</u>	234/237
<u>OLIVER</u>	224/227
<u>PIXEL</u>	242/245
<u>QUIZ1</u>	246/249
<u>QUIZ1 SLIM</u>	254/255
<u>QUIZ3</u>	254/255
<u>QUIZ4</u>	250/253
<u>SPIDER</u>	238/241



MOTION

**FDESIGN**<sup>®</sup>  
ITALIA



Spazioso ed elegante in modo essenziale e informale, il divano modulare componibile Aida richiama l'idea di un luogo felice, destinato al relax e a riposanti vacanze dello spirito. Il gioco calibrato degli incastri dà vita a un disegno proporzionato e perfettamente equilibrato, a una composizione di sapore industrial in cui ogni elemento trova la giusta posizione e svolge il corretto ruolo. Superfici più morbide e angoli più arrotondati caratterizzano invece i cuscini aggiuntivi alti, inclinati per assecondare la postura della schiena.

Spacious and elegant in a simple, informal way, the modular Aida sofa instantly conjures up happy thoughts, encouraging you to take a period of relaxation and spiritual regeneration. The carefully calibrated, interlocking structure makes for a well-proportioned, perfectly balanced design - a piece with an industrial flavour where every element is in the right place, fulfilling the right role. There are softer surfaces and more rounded corners from the tall, inclined additional cushions, which are designed to adapt to the posture of the back.





AIDA







Compattezza e soffici ta  si uniscono nel medesimo concetto di divano permettendone sia l'uso pi  formale che quello di estremo relax; dalle configurazioni pi  tradizionali a quelle pi  dinamiche rese possibili da una serie di componenti singoli che animano lo spazio living: terminali, angolari, centrali, chaise-longue. Ogni elemento   come la tessera di un puzzle da unire ad altre per definire il proprio ambiente domestico.

Volumi compatti capaci di adattarsi allo spazio, alle esigenze dell'individuo e ai suoi gusti, oltrech  alla sua evoluzione abitativa negli anni trasformandosi agilmente in nuove composizioni.

Compactness and softness come together in the same sofa concept, making it suitable for a more formal use both also for extreme relaxation; from the most traditional configurations to the more dynamic ones made possible by a series of individual components that animate the living space: end units, corner units, central units, chaise-longues. Each element is like a piece of a puzzle to be joined with others to define its creator's own home environment.

Compact volumes capable of adapting to the space, the needs and tastes of the individual, as well as to the evolution of his or her living requirements over the years, easily changing into new compositions.







Felice connubio tra l'appeal del design, evidente nella geometria rigorosa dei suoi volumi, e l'approccio haute couture nella confezione sartoriale precisa e meticolosa, Bentley è una tra le creazioni che esprime al meglio l'attitudine artigianale più autentica della FDESIGN ITALIA. Le impunture laterali del bracciolo creano un effetto di trapuntatura che ne identifica l'estetica e conferisce un'immediata idea di stile e comfort. L'ampio abaco, che comprende divani singoli dalla forte personalità e moduli componibili, permette di ottenere configurazioni originali, liberamente personalizzabili grazie alla scelta di elementi e rivestimenti esclusivi.

A virtuous combination of its design appeal, visible in the rigorous geometry of its volumes, and the haute couture approach exemplified by its precise, meticulous sartorial craftsmanship, Bentley is one of the creations that best expresses the most authentic artisanal attitude of FDESIGN ITALIA. The lateral stitchings of the arm identifies its look and instantly provides a sensation of style and comfort. The wide range, comprising sofas with strong character as well as modular elements, allows for the creation of original configurations, freely customisable thanks to the extensive choice of elements and exclusive coverings available.









Con la naturale eleganza della sua presenza, Matrix è perfetto per interni residenziali, ma rivela una forte attitudine hospitality, grazie alla sua versatilità compositiva. Le svariate configurazioni del sistema, con il segno fluido delle sue forme e l'equilibrio dei suoi volumi morbidi, permettono di disegnare sia situazioni intime e raccolte, sia schemi articolati in più elementi e a misura di spazi importanti.

With its natural elegance, Matrix is ideal for residential interiors, but also reveals a strong vocation for the hospitality sector, thanks to its versatile modularity. The many different layouts of the system, with the fluid line of its shapes and the equilibrium of its soft volumes, are perfect for creating both small, intimate spaces, as well as arrangements featuring several elements, all fit to occupy larger spaces with grace.







Un gioco di sfaccettature anima e interrompe il cubismo che contraddistingue la morfologia del sistema Concord. Caratterizzato da un'ampia progettabilità, oltre a offrire molteplici possibilità di composizioni più tradizionali, Concord vede l'intervento di presenze creative, veri elementi di sorpresa che spezzano lo schema compositivo creando un punto di interesse stilistico, oltre a interrompere l'effetto continuo del rivestimento. Una soluzione estetico-formale resa possibile dal know-how progettuale unito al savoir-faire della confezione sartoriale che da sempre identifica l'azienda..

A faceting effect livens up and interrupts the cubism that sets the morphology of the Concord system apart from the clichés of modern design. Characterised by its suitability for use in a wide range of different contemporary and traditional arrangements, Concord also features glints of pure creativity, true elements of surprise which break up the compositional layout, creating a stylistic point of interest, and interrupting the continuous effect of the covering. A solution designed to optimise both look and form, created with the know-how about design and the savoir-faire associated with fine tailoring that have always distinguished the company.









Ecco una formula vincente dell'officina di idee FDESIGN. Una creazione contraddistinta da linee sobrie e forme eleganti, un modello che si adatta ad ogni tipo di esigenza domestica e offre risposte adeguate alle più svariate necessità. Inoltre la funzionalità del suo meccanismo recliner è supportata da una forte connotazione tecnologica e da un rigoroso studio stilistico ed ergonomico, che permettono di dare vita ad un prodotto d'eccellenza, in termini di qualità, versatilità e lavorazione.

Here is the secret for success of FDESIGN's workshop of ideas. A creation based on simple yet smart shapes, a model which adjusts to any domestic requirements and properly answer a variety of needs. In addition, it stands out as functional, but it is also enhanced by state-of-the art technology as well as rigorous stylistic and ergonomic studies, which result in a top-notch product, in terms of quality, versatility and working techniques.







Un'isola flottante dalle linee squadrate che segna l'orizzonte dello spazio living. Non solo le dimensioni caratterizzano questo modello, ma anche la sua inedita morbidezza, capace di mantenere una precisa estetica formale. Il comfort è infatti garantito da una tecnologia innovativa, che vede l'utilizzo di poliuretani a densità variabili che consentono di mantenere la memoria delle forme e far ritornare la seduta in assetto, modellandosi a seconda di chi accoglie. L'impuntura che diventa dettaglio grafico, nel suo astrattismo geometrico valorizza l'identità di Decor, un modello capace di ispirarsi alla sua storia estetica e di estrema qualità nei dettagli sartoriali, evolvendola con tecnologia e sofisticazione.

A floating island with square lines that marks the horizon of the living space. It is not only the dimensions that characterise this model, but also its unprecedented softness, capable of maintaining a precise formal aesthetic, despite its welcoming sinkable effect. Comfort is in fact guaranteed by an innovative technology that uses variable-density polyurethanes that allow the memory of the shapes to be maintained and the seat to return to its original form, modelling itself to the shape of the user. The stitching, which becomes a graphic detail, in its geometric abstractionism enhances the identity of Decor, a new addition to the collection that is able to draw inspiration from its aesthetic history and the extremely high quality of its tailoring details, evolving it with technology and sophistication.





SECRET







Eleganza, unicità e innovazione. Secret definisce il design senza tempo dell'azienda. Un programma articolato di sedute modulari che offre ampia flessibilità e personalizzazione, garantendo un'interpretazione originale degli spazi e grande versatilità d'uso. Il suo design lineare ed essenziale, i volumi compatti e il meccanismo letto trasformabile e il meccanismo recliner, sono gli elementi che hanno decretato il grande successo di questo modello oltre ad aver inaugurato un vero e proprio trend nel settore.

Elegance, uniqueness and innovation. Hamilton embodies timeless company design. A wide range of modular seating systems offers great flexibility and many customisation options, guaranteeing original interior design and highly versatile use. Its minimal linear design, compact volumes, its characteristic electrowelded mechanism and recliner system are the factors that have made Secret such a huge worldwide success, setting a real sector trend.







Un divano che entra da protagonista in ogni ambiente e spazio living. Lampada led con sistema touch e attacco USB, sistema audio, poggiatesta regolabile su ogni seduta, poggiareni integrato, funzioni recliner e salva-spazio: impossibile chiedere di più.

Grazie alle dimensioni compatte, il divano Prisma riesce ad adattarsi facilmente alle diverse esigenze abitative come appartamenti di dimensioni contenute, camere/studio e case vacanze. La combinazione di funzione letto e meccanismo reclinabile rende inoltre questo modello ideale sia come letto che come divano.

A sofa that becomes the star of every living room and space. Led lamp with touch system and USB connection, sound system, adjustable headrest on each seat, integrated lumbar support, recliner and space-saving functions: you could ask for no more.

Thanks to its compact size, the Prisma sofa easily adjusts to different space-related needs, such as those of small apartments, study rooms and holiday homes. The combination of bed function and recliner mechanism makes this model ideal both as a bed and as a sofa.





Un'autentica galassia di comfort, design e innovazione. Linee avvolgenti si combinano a una modularità estrema e a funzioni salva-spazio e recliner di nuova generazione, che attivano lo schienale su ogni seduta ottenendo la posizione desiderata.

An authentic galaxy of comfort, design and innovation. An enveloping design is combined with extreme modularity, space-saving features and a latest-generation mechanism, allowing you to activate the back on each seat to obtain the desired position.



TRILUSSA







TRILUSSA SLIM



# TRILUSSA SLIM

Trilussa è un divano dallo stile inconfondibile caratterizzato dall'accurata trapuntatura dei braccioli e dal taglio laser dei piedi metallici che contraddistinguono un progetto moderno ed elegante. Inoltre la rigosità delle forme, evidente nei braccioli e nello schienale, si coniuga con la morbidezza delle imbottiture per un confort senza eguali ed un impatto visivo eccellente. Trilussa diventa con semplicità protagonista degli ambienti che abita.

Il modello è dotato, nella versione con funzione relax, dell'esclusivo meccanismo "Spazio" che permette di reclinare lo schienale ed allungare la seduta, in un unico movimento, senza dover allontanare il divano dalla parete.

Trilussa is a sofa with a unique style, with its refined quilting arms and laser-shaped metal feet that give it a modern and elegant aspect. The clear and precise shape of the armrests and backrest pair perfectly with the softness of the padding, offering a peerless comfort and a stunning visual impact. Trilussa naturally becomes the true focal point of any space in which it is placed.

The model is equipped, in the recliner function, with the exclusive "Spazio" mechanism: the seats and backrest move, inclining forward as the sofa opens so there's no need to keep it away from the wall.





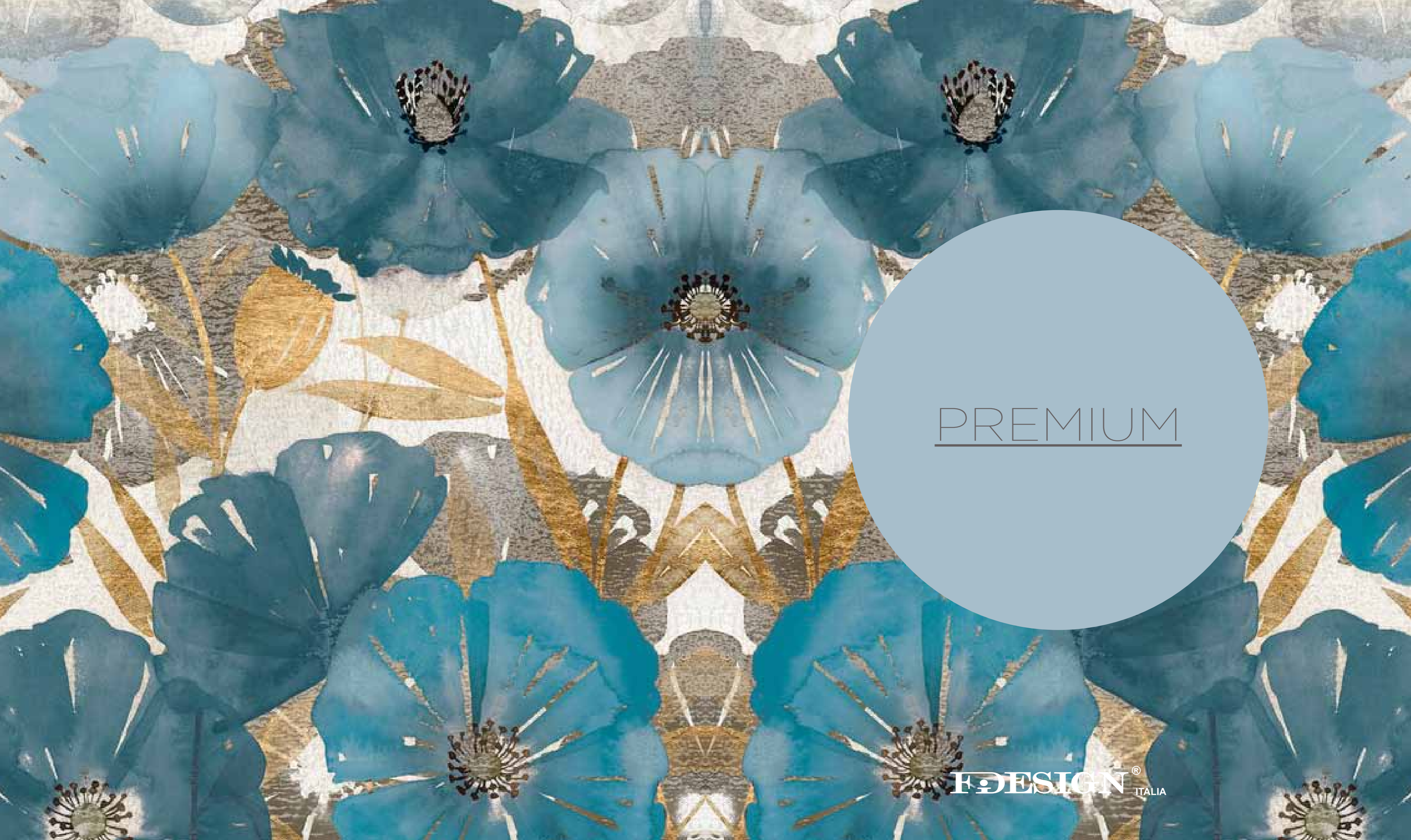

PREMIUM

**DESIGN**®  
ITALIA



Gassman è un divano votato al massimo comfort. Estetica e funzione convivono in armonia nelle sue forme rilassate. I morbidi volumi della seduta sono circondati da una cucitura a coda di topo, dettagli sartoriali che conferiscono carattere al progetto. Il comfort è assicurato dall'imbottitura in poliuretano a cui si aggiunge una speciale fibra anallergica leggera e traspirante. Lo sviluppo tecnico non sovrasta l'estetica sofisticata, dal sapore classicheggiante, che fa di Gassman un passepartout per una casa che pone al centro i momenti condivisi.

Gassman is a sofa whose aim is to provide maximum comfort. Aesthetics and function coexist in harmony in its relaxed forms. The shape of the armrest is emphasised by the folds in the fabric, while the soft volumes of the sofa are profiled with rat-tail stitching - and it's these sartorial details that add character to the piece. Comfort is provided by polyurethane padding supplemented by a special light and breathable hypoallergenic fiber. The technical features do nothing to overshadow the sophisticated, classical aesthetics of the sofa itself, making Gassman the perfect way to make shared moments the centre of the home.











Sobrietà delle linee, generoso volume delle sedute, il modello Ocean invita a rilassarsi con stile.

Le molteplici composizioni possibili e l'ampia varietà di rivestimenti disponibili rendono questo modello un must have delle collezioni FDESIGN.

Sober lines, generous volume of the seats, the Ocean model invites you to relax in style.

The multiple possible compositions and the wide variety of available coverings make this model a must have of FDESIGN collections.









Nathan afferma uno stile molto preciso, contemporaneo, minimale, che ha radici nella storia dell'azienda. Un modello che si presenta altamente innovativo per la reinterpretazione di forme del passato, la cui semplicità apparente diventa vera bellezza e nasconde la sua grande complessità progettuale: nella giustapposizione di materiali diversi e ricchi di espressività, offre una nuova lettura dello stile identitario della FDESIGN. Un design che guarda al futuro, progettato per durare nel tempo e diventare un nuovo best seller.

Nathan has an ultra-precise, contemporary, minimal style. A model with a highly innovative profile that reinterprets shapes from the past, transforming their apparent simplicity into a form of real beauty that conceals an intricately complex design concept: by juxtaposing different materials with strong powers of expression, it offers a new take on the distinctive style that identifies FDESIGN brand. A design that looks to the future, made to stand the test of time and become a new best seller.











Con le sue sedute profonde e i suoi larghi cuscini trapuntati, il divano Russel è un richiamo ad accoccolarsi. La sua linea informale, il suo confort e le sue dimensioni generose ne fanno un divano particolarmente conviviale.

With its deep seats and large tufted pillow cushions, the Russel sofa is incredibly inviting. The relaxed shape, extraordinary comfort, and generous size make it a particularly consumer-friendly sofa.





Quadro crea e contrasta colori e forme, sottolinea la qualità e le possibilità che i materiali offrono. La sintesi di questo lavoro trova uno sbocco istintivo in un prodotto dal design sapientemente semplice e coerente, dove nulla è lasciato al caso, ma tutto appare naturale, dove colori e dimensioni sono studiati per dare il meglio senza eccesso, dove poter cogliere una tranquilla, piacevole empatia fra natura e prodotto. La schiuma di poliuretano di alta qualità, assieme alla Memory Foam, garantisce un grande comfort di seduta mantenendo l'aspetto invariato nel tempo.

Il modello è inoltre dotato dell'esclusivo meccanismo "Mitico" che consente di cambiare la posizione della seduta semplicemente traslando gli schienali fino ad ottenere un comfort ottimale.

Quadro creates and contrasts colours and shapes. This intrinsic synthesis leads to a naturally evolving design all in a coherent style, where colours and dimensions are studied to create harmony without excesses, a style which is able to convey an empathy between nature and product. Seat cushion is loose and includes a layer of memory foam, a pressure-sensitive soft polyurethane, which recovers its form completely for ultimate style and comfort. The model is equipped with the exclusive "Mitico" mechanism which lets you change the position of the seat simply by sliding the backs to achieve absolute comfort.







Un'autentica galassia di comfort, design e innovazione. Linee avvolgenti si combinano a una modularità estrema e a funzioni salva-spazio e recliner di nuova generazione, che attivano lo schienale su ogni seduta ottenendo la posizione desiderata.

An authentic galaxy of comfort, design and innovation. An enveloping design is combined with extreme modularity, space-saving features and a latest-generation mechanism, allowing you to activate the back on each seat to obtain the desired position.









Monza è contraddistinto da un design sofisticato e senza tempo. Le sue proporzioni perfette ed i suoi preziosi dettagli estetici sottolineano il cuore artigianale del prodotto. I piedi sono in una particolare finitura in metallo grigio scuro verniciato a polvere. La sua versatilità lo rende perfetto in ogni ambiente. Divano concepito per un total look d'eccezione

Monza is based on a sophisticated and timeless design. Its proportions are excellent and its precious aesthetic details emphasize the handcrafted heart of the product. The feet are in a special dark grey powder coated metal finish. Monza's versatility makes it perfect for any environment. Sofa designed for an exceptional total look.



Caratterizzato da un design ricercato, il divano Nilos presenta forme estremamente morbide che garantiscono un alto livello di comfort, con sedute ampie e schienale basso, invita al più profondo relax. La sinuosità delle forme si fonde con la base più moderna per rispondere in maniera sublime alle più disparate esigenze di arredamento. Un testimonial di eleganza, ricercatezza e alta artigianalità.

With its stylish design, soft shapes Nilos sofa provides the ultimate comfort experience with ample seats and a low backrest that promise a deeply relaxing seating experience. Its soft rounded shapes combined with a modern looking base are the best response to the most diverse interior design needs. An epitome of elegance, refinement and craftsmanship.





Lugano unisce la bellezza ed il gusto un po' classico reinterpretato in chiave moderna con linee minimali, senza dimenticare il comfort della seduta e dell'alto schienale. Giovane e grintoso Lugano si compone di forme armoniche e sinuose che si muovono a seconda delle esigenze dello spazio. All'alto valore estetico si aggiunge la qualità della sua realizzazione: raffinati dettagli conferiscono a questo modello una personalità davvero chic.

Lugano combines the beauty and a bit classic taste reinterpreted in a modern key with minimal lines, without forgetting the comfort of a seat and high back. Young and aggressive, Lugano consists of harmonic and sinuous forms that move according to the needs of the space. The quality of its realization adds to high aesthetic value: refined details give this model a personality really chic.





Divano imponente e di pregiata manifattura. Tonic è un progetto di grande comfort già dal primo sguardo. Contribuiscono alla grande comodità, i larghi braccioli e le ampie sedute assieme al supporto lombare. Il divano, curato in ogni minimo dettaglio, è ammirabile a 360°, dunque perfetto anche al centro di una stanza.

An imposing and perfectly crafted sofa. Tonic gives an impression of comfort right from the first glance. The wide armrests and seats and lower back support make it extremely comfortable. The sofa is meticulously crafted and extremely attractive from any angle, making it the perfect centerpiece for a room.











Un'armonia di contrapposizioni ed equilibri per il divano Fashion, un divano contemporaneo caratterizzato da linee orizzontali e attento al comfort: nuovo, armonico e leggero.

Ideale anche in ambienti di grande dimensione dove realizzare il proprio spazio di design e relax.

Fashion is characterized by harmony of contrasts and aesthetic balance. A contemporary sofa featuring a prevalence of horizontal lines, with a focus on comfort: new, harmonious and light. Also ideal in large rooms, to create your own space of design and relaxation.





Onda è un divano dallo stile inconfondibile caratterizzato dall'accurata trapuntatura e dalla forma dei piedi metallici che contraddistinguono un progetto moderno ed elegante. Inoltre la rigorosità delle forme, evidente nei braccioli e nello schienale, si coniuga con la morbidezza delle imbottiture per un confort senza eguali ed un impatto visivo eccellente. Onda diventa con semplicità protagonista degli ambienti che abita.

Il modello è inoltre dotato dell'esclusivo meccanismo "Mitico" che consente di cambiare la posizione della seduta semplicemente traslando gli schienali fino ad ottenere un confort ottimale.

Onda is a sofa with a unique style, with its refined quilting and specially-shaped metal feet that give it a modern and elegant aspect. The clear and precise shape of the armrests and backrest pair perfectly with the softness of the padding, offering a peerless comfort and a stunning visual impact. Onda naturally becomes the true focal point of any space in which it is placed.

The model is equipped with the exclusive "Mitico" mechanism which lets you change the position of the seat simply by sliding the backs to achieve absolute comfort.





Reinterpretazione in chiave moderna di un classico chester, il divano Vogue, capolavoro di artigianato, si caratterizza per le linee tese lungo tutto il perimetro che avvolgono il dettaglio del capitoné e la morbidezza dei cuscini. Nel gioco fra esterno e interno prende forma un divano dal design unico, che non rinuncia ad una straordinaria comodità grazie alle pregiate imbottiture inserite nell'avvolgente spalliera e nella profonda seduta.

A modern interpretation of a classic Chester sofa, Vogue is a masterpiece of craftsmanship, featuring lines that run all around its perimeter enclosing the tufting detail and the softness of the cushions. The play between outside and inside creates a unique design combined with superior comfort, thanks to the high-quality padding of the enveloping backrest and deep seat.





POLTRONCINE  
SINGLE CHAIRS







Kallas è una poltrona con una spiccata personalità, caratterizzata da una silhouette dal segno leggero. La linea raffinata e avvolgente è sottolineata dalla curva morbida della scocca che disegna il bracciolo e che accoglie un cuscino schienale dalle forme morbide. Con la sua forte identità formale e le sue proporzioni impeccabili, Kallas diventa protagonista dello spazio che la accoglie, sia esso di tipo residenziale che hospitality.

Kallas is an armchair with a strong personality, characterised by the light silhouette. The soft curve of the shell, which designs the armrest and that accommodates the soft back cushion, highlights the pure and enveloping line of the armchair. With its firm formal identity and its impeccable proportions, Kallas becomes the protagonist of the space that welcomes it, both in residential and hospitality contexts.







Poltrona fissa o girevole, Diva è stata progettata per poter rispondere a svariate esigenze, sia in termini di funzionalità che di ergonomia, declinate nelle diverse tipologie. E' il risultato di una grande ricerca per esprimere al meglio la semplicità sofisticata della confezione.

Armchair or swivel armchairs, Diva was designed to meet a variety of requirements, both in terms of functionality and ergonomics, available in a range of different types. It is the result of the in-depth research carried out to find the best way to express the sophisticated simplicity of the craftsmanship.







La pregiata lavorazione capitonné contraddistingue un emblema del design e dell'alta artigianalità. Questo modello porta valore in ogni tipo di ambiente, anche moderno, grazie al suo stile senza tempo. La tradizione incontra la modernità, per un divano compatto dallo stile inconfondibile.

The precious capitonné workmanship distinguishes an emblem of design and high craftsmanship. This sofa enhances every type of room, even modern environments, thanks to its timeless style. Tradition meets modernity, producing a compact sofa with an unmistakable style.





Morbida nella linea sinuosa e simmetrica, forte nei colori del rosso corallo. Con la libertà compositiva e di personalizzazione dovute al design forte e scenografico e il valore ergonomico e funzionale della struttura diventa la poltrona ideale dove esprimere al meglio la propria creatività.

Soft in its sinuous, symmetrical shape, vivid in its coral red colour. With its free arrangements, customization options as based on outstanding, scenic design and its ergonomic, functional frames, it becomes an ideal armchair where you can make the best of your creativity.







FAST



Stile e comodità fanno di Agorà un divano protagonista e senza tempo. Le ampie sedute sono abbracciate da trapuntature impreziosite da bordi e tagli finemente lavorati, un continuo invito ad accomodarsi. La rigorosità delle forme, evidente nei braccioli e nello schienale, si coniuga con la morbidezza delle imbottiture per un confort senza eguali ed un impatto visivo eccellente. Il divano si adatta perfettamente sia ad ambienti classici che moderni con eleganza e semplicità artigianale.

Style and comfort make Agorà an excellent and timeless sofa. The wide seats are embraced by quiltings with beautifully worked edges and cuts, tempting you to sit down and enjoy the comfort. The clear and precise shape of the armrests and backrest pair perfectly with the softness of the padding, offering a peerless comfort and a stunning visual impact. The sofa is ideal for both classic and contemporary settings, with the elegance and simplicity of a true craftsman's skill.





Un profilo rigoroso, netto e squadrato, addolcito dalla raffinata trapuntatura dei cuscini di seduta. Hilton ha proporzioni armoniose che nascono e si sviluppano intorno al desiderio di creare e valorizzare un oggetto multifunzionale e leggerissimo.

Un divano sofisticato, sia nella versione in tessuto che in pelle: la seduta comoda si valorizza nelle combinazioni componibili, anche con l'elemento chaise longue.

A rigorous, clear, squared silhouette, softened by its distinctive quilted sitting cushions. Hilton has harmonious proportions which were born and developed around the desire to create and bring out a multipurpose and lightweight model. A sophisticated sofa, both in the fabric and leather cover version: the comfortable seat shows all its potential in the combinations of components, including a chaise longue element.





Design moderno, stile originale, linee leggere. Ingrid propone un relax straordinario e porta in ogni living un tocco di personalità ed eleganza.

Il divano Ingrid è caratterizzato da ampie e profonde sedute che riportano facilmente alla comodità del divano già dal primo sguardo. Le sue forme morbide sono contornate da eleganti braccioli e valorizzate dai cuscini poggiatesta volanti. Un ulteriore tocco di stile è assicurato dai piedi in metallo pressofuso.

A modern, light design with an original style: Ingrid offers extraordinary relaxation and brings a touch of personality and elegance to every living area.

Ingrid features deep ample seats that convey an impression of comfort at first glance. Its soft shapes are contoured by elegant armrests and emphasized by removable cushions for extra back support. The die-cast metal feet add a touch of style.







Sempre tesi alla sperimentazione di soluzioni innovative e grazie ad una continua attività di ricerca siamo lieti di presentarvi Sparta. Pensato per durare nel tempo e per questo versatile nella sua funzione e adatto ad ogni stile e gusto, Sparta sottolinea la ricerca dell'azienda verso soluzioni d'arredo che creino un'atmosfera contemporanea, ma senza eccessi.

Committed to testing innovative solutions and thanks on ongoing research we are proud to introduce you Sparta. Conceived to last over time, and thereby versatile in function and suitable for every style and taste, Sparta highlights the company's research into furnishing solutions that create a contemporary atmosphere that is not overdone.





Filo conduttore di Michela è la semplicità delle forme, volta a creare un prodotto fresco, in grado di dialogare con l'interno della casa. Un gioco di trasparenza, un'estremizzazione della leggerezza di una linea che non sovrasta il progetto di arredo globale, ma a questo si integra e lo completa. Michela testimonia la vitalità di un design capace di trasformare i vincoli in stimolanti opportunità d'innovazione.

The hallmarks of Michela share simple lines, translating into a fresh product, which can interact with home interior. Transparency, lightness as carried to extremes, the shapes harmonizing with overall interior design project, rather than "threatening" it. Michela testifies to the vitality of design as capable of changing constraints into attractive opportunities for innovation.





Lupin diventa protagonista della zona giorno, per creare un angolo raccolto in un grande living o disegnare uno spazio speciale dedicato al relax. Due dettagli da non perdere sono l'alto schienale e il bracciolo imbottito risvoltato su un sottile telaio, per rendere ancora più accogliente la linea. Compatto, accogliente, disinvolto: pensato per un ambiente contemporaneo e conviviale. Per lunghe letture, per una notte di film. Un divano rifugio, per accoccolarsi un po'.

Lupin becomes the protagonist of any living area, to create a cozy corner in a large space or a special zone set aside for relaxation. Two important details are the high back and the padded armrest, folded back over a slender frame to make the lines even more appealing. Compact, comfortable, nonchalant: designed for a contemporary, convivial environment. For a book you can't put down, or a long night of cinema. A sofa-refuge, for cuddling and cuddling.





Filo conduttore del progetto di Plaza è la creazione di un modello giovane, dinamico, capace di attirare il cliente, che viene emotivamente coinvolto in un ambiente variegato, dalle tante sfaccettature, in cui la percezione visiva arriva direttamente ai sensi, coinvolgendoli nel percorso creativo. Meccanismi a scomparsa, colori e finiture cromo-satinate lo rendono adatto a qualsiasi ambiente.

The guiding principle of Plaza project is the creation of a young and dynamic model which would attract a client through an emotional involvement in a varied and diversely articulated environment where the visual perception strikes the senses directly, involving them in a creative process. Based on its foldaway mechanisms, colours and matt chrome-plated finishes, it suits any room.





Filo conduttore del progetto di Levante è la creazione di un modello giovane, dinamico, capace di attirare il cliente, che viene emotivamente coinvolto in un ambiente variegato, dalle tante sfaccettature, in cui la percezione visiva arriva direttamente ai sensi, coinvolgendoli nel percorso creativo. Meccanismi a scomparsa, colori e finiture cromo-satinate lo rendono adatto a qualsiasi ambiente.

The guiding principle of Levante project is the creation of a young and dynamic model which would attract a client through an emotional involvement in a varied and diversely articulated environment where the visual perception strikes the senses directly, involving them in a creative process. Based on its foldaway mechanisms, colours and matt chrome-plated finishes, it suits any room.





CLASSIC

**FEDSIGN**®  
ITALIA



Una forte identità progettuale, frutto di un'assidua ricerca e creatività. Il risultato? Elite, un modello che diventa quasi specchio rivelatore dell'espressione della mente e dei contenuti del cuore. Questo modello mette a fuoco il binomio bellezza-funzionalità, mentre la magia delle forme lineari si sposa con la poesia della lavorazione capitonnè. Il segreto di questo modello è la capacità di combinare il gusto della tradizione con le esigenze funzionali attuali in nome di un prodotto di design 'modern style' caratterizzato dalla ricchezza dei materiali e dalla cura dei dettagli.

A powerful design identity, the result of assiduous experimentations and creativity. What is the result? Elite, a model looking like a mirror which reveal both the expression of the mind and the contents of the heart. This model stresses on beauty-functionality, whereas the magic of its linear shapes harmonizes with the poetry of capitonnè technique. The ability to match a taste for tradition with current functional requirements in the name of modern style designer products enhanced by rich materials and accurate details is the main secret for success of this model.







Emporio è caratterizzato da ampie e profonde sedute che riportano facilmente alla comodità del divano. Le sue forme morbide e sinuose sono contornate da sottili braccioli e valorizzate dai cuscini poggiatesta volanti.

Le caratteristiche rétro enfatizzano l'artigianalità del capitonné riprodotto sullo schienale di importanti dimensioni. Si ha così una interpretazione contemporanea dello stile classico. Ne risulta una personalità molto forte che arricchisce l'ambiente in cui viene collocato. Il sogno di avere a disposizione tanto spazio finalmente si realizza.

Emporio is characterized by its generously proportioned seats and unique comfort. Its soft, sinuous shape and thin, sculptural armrests are enhanced by loose lumbar cushions. Vintage features highlight the craftsmanship of the Chesterfield back of important dimensions. Thus there is a contemporary interpretation of the classic style. Wherever you position it, its strong personality inhabits the space around it. Finally the dream of space in abundance comes true.





Lo stile Chesterfield non muore mai, ma Vanity non è solo un tributo a questo genere. Il divano Vanity rappresenta l'evoluzione tecnologica dell'azienda, mentre le sue proporzioni perfette ed i suoi preziosi dettagli estetici sottolineano il cuore artigianale del prodotto: la sua forma particolare e la lavorazione capitonnè sulla parte interna ne sono un esempio. Ad oggi, questo divano è il punto più alto di comfort e morbidezza che si possa raggiungere, indipendentemente da quale delle sue numerose opzioni di stile si finirà per scegliere.

Chesterfield style never dies, but Vanity is not just a tribute to it. Vanity epitomizes the technological evolution of the company; its perfect proportions and fine aesthetic details highlight the craftsmanship inherent in the product. Examples include the special shape and the capitonnè technique on the backrest. As of today, this sofa is the highest point of comfort and softness you can reach, no matter which one of its several style options you'll end up choosing.





LUXOR









# ALBATROS

Un prezioso oggetto di arredamento e design che porta lo stile inconfondibile e la qualità di FDESIGN nelle case di tutto il mondo. Un progetto di lifestyle italiano nel quale la tradizione è sempre reinterpretata in chiave innovativa e contemporanea. Albatros si articola in una grande varietà di rivestimenti, accessori decorativi e versioni, tutti progettati e realizzati utilizzando i migliori materiali e finiture di pregio. La produzione è realizzata "a mano" per il 90% e curata da artigiani italiani utilizzando le tecniche tradizionali del Made in Italy.

A furniture and prestigious design object that bring the unique FDESIGN flavour into homes all over the world. A pervasive lifestyle project where tradition is never nostalgic and innovation is paramount. Albatros contains a large variety of coverings, decorative accessories and versions, all designed and manufactured using the finest materials and exclusive finishes. The production is 90% handcrafted by Italian artisans using traditional techniques in Italy.



Il design ad alto livello, articolato all'interno di un palcoscenico poliedrico e fluido, è rivelazione di un art de vivre raffinata che diventa filosofia dell'abitare. Pensato per una platea internazionale alla costante ricerca di oggetti lussuosi e unici, con grande attenzione per i dettagli e una profonda sensibilità estetica, Dalì rivela un design ineguagliabile, modellato da artigiani esperti secondo la migliore tradizione italiana e crea un'atmosfera esclusiva con il suo stile inconfondibile dove eccellenza e classe si fondono perfettamente.

The high-level design, showcased on a multi-faceted and fluid stage, reveals a sophisticated art de vivre, translating into a living philosophy. Caters to those who are in a relentless pursuit of both luxury and sophistication, with aesthetics and attention to the slightest details in mind, Dalì reveals a peerless design, using the finest of Italian tradition and workmanship and creates exclusive atmospheres with its unmistakable style where luxury and class blend perfectly.









Relax in primo piano per il divano Royal. L'accurata lavorazione artigianale della pelle, insieme ad una tecnologia studiata e funzionale ne fanno un prodotto di alta qualità. Un pezzo storico, con funzionalità e comfort attuali, ideale sia per contesti classici che contemporanei e che riscuote grande attenzione per lo charme con cui arreda la stanza. Ai richiami del passato Royal abbina forme generose, morbide e sinuose, esaltate da finiture pregiate, frutto di processi produttivi che coniugano bene tecnologia e artigianalità. Un prodotto unico, dunque, di grande suggestione e fascino senza tempo.

Relax is the imperative for Royal sofa. The careful handcrafting of the leather, along with the meticulous and functional technology make it a product of fine quality. An historic piece, relying on current functionability and comfort, thus suiting both classic and contemporary settings and which wins praise for its charming design. The lure of the past harmonizes with generous, soft, sinuous shapes, enhanced by fine finishes, as the result of manufacturing processes synonymous with a blend of state-of-the-art technology and exquisite craftsmanship. Hence the emphasis is on unique charming, timeless product.





DIVANI LETTO  
SOFA BEDS







Filo conduttore di questo modello è stato la doppia anima del tempo, il giorno e la notte, che si evolve cambiando aspetto, modificando le atmosfere, le sensazioni, gli scenari. Il suo meccanismo letto ha un sistema di apertura semplice ed unico, che consente di non rimuovere i cuscini della seduta e dello schienale del divano. È inoltre fornito con innesti a baionetta che facilitano il montaggio e smontaggio (braccioli, schienale, fascia) del divano, risolvendo il problema della movimentazione durante il trasporto. Il telaio è in tubo da mobilio ad alta resistenza con verniciatura epossidica e il piano dormita è con rete in acciaio elettrosaldato e cinghie elastiche. Può essere fornito di materasso in poliuretano indeformabile rivestito in cotone sfoderabile.

The two souls of time-day and night-, which evolve while changing appearance as well as atmospheres, feelings and scenarios, meant the common thread throughout this model. Its bed mechanism has a simple, single opening system that makes it possible to leave the seat and back cushions in place on the sofa. The mechanism has furthermore bayonet joints that make assembly and disassembly of the sofa (armrests, back, front panel) easier and which solve handling problems during transport. The frame is in ultra-strong furniture tubing painted with epoxy powders, while the sleeping surface is with base in electrowelded (fuse-bonded) steel and elastic straps. The sofa is available with not-deformable polyurethane mattress with removable cotton cover.









Lo schienale alto e ampio per sedersi composti a conversare, protetti da sguardi indiscreti: Amalfi ha un fascino d'altri tempi ma in chiave contemporanea. Una scelta d'effetto dove emerge la capacità di proporre non solo un modello ai vertici della qualità, ma una soluzione progettuale completa e dal contenuto fortemente innovativo.

An elegant sofa with a wide, full back for decorous seating and conversation, shielded from prying eyes. Amalfi has bygone charm but in a contemporary way. A striking choice where the capacity to propose is not limited to the model at the very summit of quality, but also to a solution for complete projects full of innovative content.





Cosa cerchi in un divano? Componibilità, comodità, poggiatesta, accessori libreria, porta riviste e vassoi svuota tasche? Tutto questo è Magnum. Look deciso e contemporaneo, resta sempre un confortevole luogo di incontro per godersi attimi di relax assoluto con la comodità di avere tutto a portata di mano grazie ai funzionali accessori abbinati.

What are sofas expected to be like? Modular, comfortable, with headrests, with a built-in bookcase, a magazine rack, storage trays? This is what Magnum is offering you. Simple, rigorous, modern: a sofa that will always be trendy. Sharp and contemporary look, it is always a comfortable meeting place to enjoy moments of relaxation with the convenience of having everything at your fingertips thanks to the functional matching accessories.









Il divano Spider risulta semplice e raffinato grazie alle sue forme squadrate ed armoniche, che ben si coniugano con gli spazi urbani solitamente non molto grandi. I piedi in metallo donano maggiore gradevolezza estetica per un complemento moderno ed essenziale. Il sistema "Pronto letto" assicura un'estrema facilità nella trasformazione, con un solo movimento, da divano a letto e viceversa. Il modello è dotato di bottoni decorativi collocati sui braccioli e sul retro schienale che contribuiscono a conferirgli un carattere unico.

Spider sofa, based on square shapes, combines simplicity and elegance for compact urban spaces. The "Ready bed" mechanism ensures ease of operation, going from sofa to bed and vice versa in one swift movement. The model is equipped with decorative buttons on the arms and back side, giving it a unique character.







**Pixel** sposa linee pure e materiali essenziali e mira a creare un ambiente intimo e privato dove rilassarsi in modo confortevole senza tralasciare la sua eleganza. Versatile, poliedrico e assolutamente discreto, **Pixel** è ulteriormente innovativo per il suo meccanismo letto che gli conferisce ulteriore versatilità e flessibilità di utilizzo. Elegante di giorno, si trasforma in pochi secondi in un pratico e comodo letto: dedicato a chi desidera il comfort assoluto.

Pixel is a blend of simple shapes and material and aims to create a private and intimate space for comfortable relaxation, without omitting a dose of elegance. Versatile, many-sided and absolutely discreet, Pixel looks further innovative as the result of its bed mechanism, which translates into further improved versatility and flexibility. Elegant by day, it transforms in just a few seconds into a comfortable bed: dedicated to those looking for absolute comfort.









# QUIZ 1 / 3 / 4 / 1 SLIM

QUIZ 1



QUIZ 1 SLIM



QUIZ 3



QUIZ 4



Quiz sposa linee pure e materiali essenziali e mira a creare un ambiente intimo e privato a rilassarsi in modo confortevole senza tralasciare la sua eleganza. Versatile, poliedrico e assolutamente discreto, Quiz è ulteriormente innovativo per il suo meccanismo letto che gli conferisce versatilità e flessibilità di utilizzo. Elegante di giorno, si trasforma in pochi secondi in un pratico e comodo letto: dedicato a chi desidera il comfort assoluto.

Quiz is a blend of simple shapes and material and aims to create a private and intimate space for comfortable relaxation, without omitting a dose of elegance. Versatile, many sided and absolutely discreet, Quiz looks further innovative as the result of its bed mechanism, which translates into further improved versatility and flexibility. Elegant by day, it transforms in just a few seconds into a comfortable bed: dedicated to those looking for absolute comfort.

















# DETTAGLI

# DETAILS

“Il design è un mezzo attraverso il quale esprimiamo le nostre esperienze, e l'azienda il luogo in cui il nostro staff lavora sinergicamente, attraverso una metodologia che si chiama squadra. Passo dopo passo, dal sapere al creare”. Il design, per noi, non ha limite, è ricerca accurata, ricerca evoluta, non certo decorazione. Al centro di tutto vi è l'uomo perché “interpretare il design non è fine a se stesso: alla linea si affianca il corpo, l'anima e lo spirito per fondersi in una sola emozione”.

Il nostro preciso obiettivo è di creare “design, oltre ogni possibile barriera di mezzo, origine e tempo”, per un portfolio multidisciplinare di clienti che ne condividano la visione tutta made in Italy.

“Design is a medium through which we can express our own experiences, and the company is the place where our staff can work synergetically, through a method called 'team'. Step by step, from knowledge to creation”.

Design is, for us, limitless; it means sophisticated search, evolved search: for sure it does not mean decoration. Man stands out from everything else, because “interpreting design is not an end in itself: form joins the body, soul and spirit, to fuse into one emotion”.

We have the precise objective of creating “design, beyond every possible barrier of means, origin and time”, for a multi-disciplinary portfolio of clients who share our made in Italy vision.

# SCHEDA PRODOTTO

Applichiamo il sistema qualità a tutte le fasi operative: dall'acquisto della materia prima alla lavorazione e sviluppo; dalla consulenza al cliente, alla vendita e consegna del prodotto. In conformità con le rigorose normative europee ed internazionali, l'azienda esegue e controlla al suo interno l'intero ciclo di lavorazione al fine di garantire il soddisfacimento dei bisogni del cliente.

**Struttura:** Legno di prima qualità (abete e multistrato) abbinato a pannelli di particelle di legno grezzo biodegradabile e pannelli di fibra di legno duro. **Molleggio seduta:** Il fusto è dotato di cinghie elastiche in polipropilene e lattice, fissate con punti metallici e disposte sia in senso orizzontale che verticale, in modo da conferire resistenza e consistenza alle sedute.

**Imbottitura:** Poliuretano espanso ad alta resilienza e ovattato faldato. Anche fiocco e piuma, opportunamente sterilizzati e resi sicuri da un punto di vista igienico-sanitario, vengono spesso coinvolti nel ciclo di imbottitura, soprattutto per le sedute e le spalliere, conferendo morbidezza, sofficià e comodità. Gran parte delle sedie e poltroncine hanno invece la struttura in acciaio interamente stampata in poliuretano schiumato a freddo.

**Rivestimento:** Pelli di origine bovina accuratamente selezionate o tessuti strutturati, cotone, lino, ciniglie, microfibre, velluti, jacquard o eco-pelli, tutti in una vastissima gamma di articoli e colori. A seconda del modello il rivestimento può essere non sfoderabile, semi sfoderabile o completamente sfoderabile, come riportato sulla scheda tecnica di ciascun articolo.

**Meccanismi:** I meccanismi letto sono tutti elettrosaldati, realizzati con tubolare metallico accuratamente verniciato con polveri epossidiche e dotati di materasso in espanso ad alta densità. Le versioni letto con contenitore sono movimentate da un meccanismo con pistoni a gas. I meccanismi poggiatesta sono movimentati da cricchetti a posizione variabile. I meccanismi recliner sono tutti "zero wall", disponibili nelle versioni manuali, elettriche ed anche alzapersona per alcune poltrone.

**Optional:** Ogni modello è dotato di elementi di serie o elementi optional, ordinabili su richiesta ed accuratamente riportati nel listino di vendita a margine di ciascuna versione.

**Rispetto dell'ambiente:** I prodotti FDESIGN sono realizzati con materiali naturali e riciclabili. Vi invitiamo perciò a rispettare l'ambiente e a contattare l'ufficio comunale competente per lo smaltimento dei rifiuti solidi urbani.

**Manutenzione:** Per prolungare la bellezza del vostro divano vi consigliamo di tenere il salotto ad almeno cm 50 di distanza da fonti di calore (caloriferi, stufe etc), di proteggerlo dalla luce diretta dei raggi solari, di pulire il rivestimento (pelle o tessuto) con l'aspirapolvere o con un panno umido almeno una volta alla settimana, di evitare di sedersi sugli schienali o sui braccioli del divano.

(In ottemperanza alle disposizioni del decreto legge 206 "Codice del Consumo")

# PRODUCT CARD

We apply the Quality System to all the Operations: from the raw material purchasing to its processing and development. In compliance with all European and International certification standards, the company runs and controls inside the whole production cycle to pledge the customer needs satisfaction.

**Frame:** Top quality wood (fir wood and multilayer) combined with panels of raw biodegradable wooden fibres and panels of hardwood fibres.

**Seating suspension:** The frame is provided with elastic straps made of polypropylene and latex, fixed with metal staples and arranged horizontally and vertically so to ensure resistance and consistency to the seat.

**Stuffing:** High resilience polyurethane foam and padding. Even polyester fibre flocks and feathers, properly sterilized and safe from a hygienic point of view, are frequently involved in the stuffing cycle and mainly used on the seats and back of sofas, conveying tenderness, softness and comfort. Quite all the chairs and armchairs have, instead, steel framework entirely moulded in cold-cure polyurethane.

**Coverings:** Carefully selected leather of bovine origins or structured fabrics, cottons, linen, chenille, microfibre, velvet, jacquard or eco-leather, all in a wide range of articles and colours. In relation to each model the covering could be non removable, partially removable or totally removable, as specified on the technical feature of each article.

**Mechanisms:** Bed mechanisms are all electro-welded, made with metal frames carefully painted with epoxy powders and equipped with high density foam mattress. Bed versions with storage underneath are operated by gas piston mechanisms. Headrests come with different positions fittings for adjustment. Recliner mechanisms are all "Zero Wall", available as manual or electrical and even lift for some armchairs.

**Optional:** Each model is equipped with serial or optional elements which are available on request with an extra cost reported on the pricelist in the margin of each version.

**Environment Respect:** FDESIGN products are made with natural and recyclable materials. We invite you therefore to respect the environment and to contact your local city office responsible for the disposal of municipal solid waste.

**Maintenance:** To keep your sofa beautiful for a long time we suggest you to keep it at least cm 50 away from heat sources (radiators, heaters etc), to protect it from direct sunlight, to keep the covering (leather or fabric) clear from dust and to clean it with vacuum cleaner or wet cloth at least once a week, to avoid to sit on the back or on the armrest of the sofa.

(In accordance with the provisions of Decree Law 206 "Consumer Code")



# AGORÀ

pag. 164/165

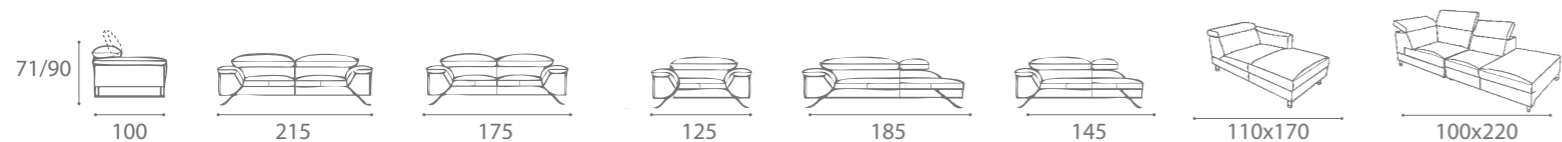

# AMALFI

pag. 228/233

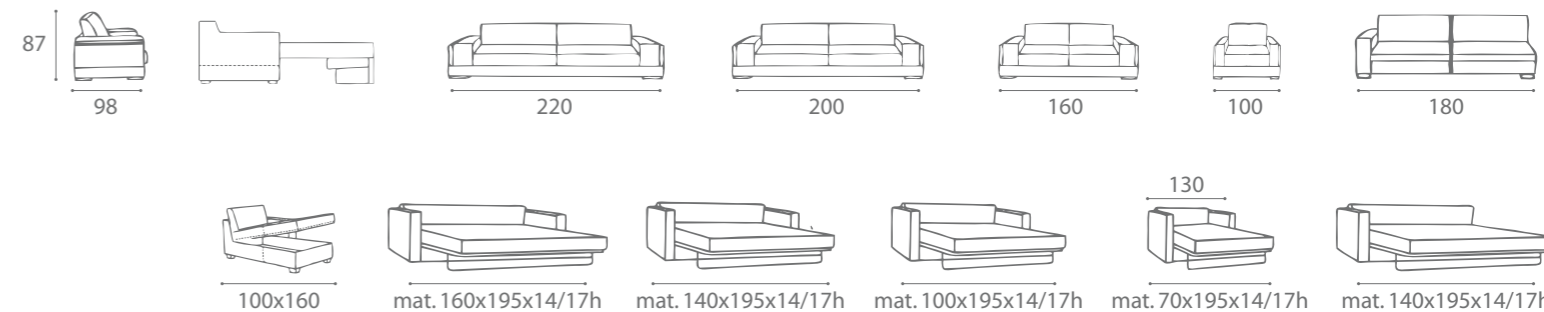

# AIDA

pag. 8/15

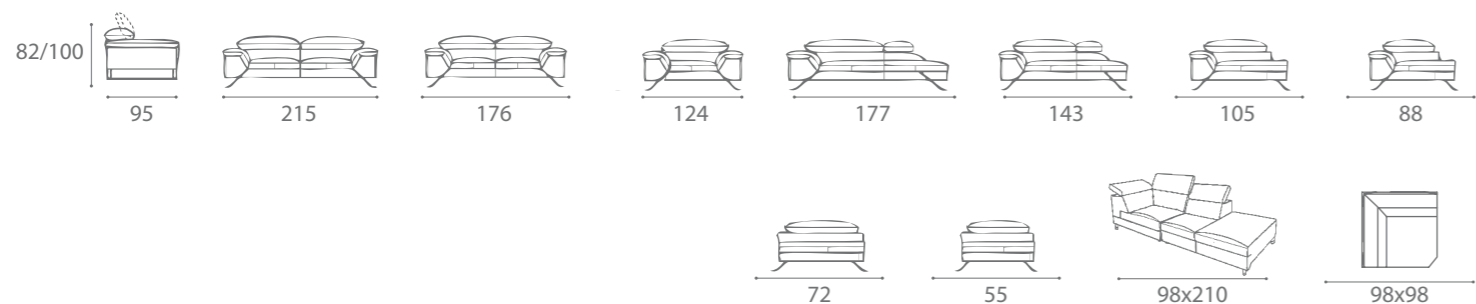

# BAZAAR

pag. 104/107



# ALBATROS

pag. 210/213

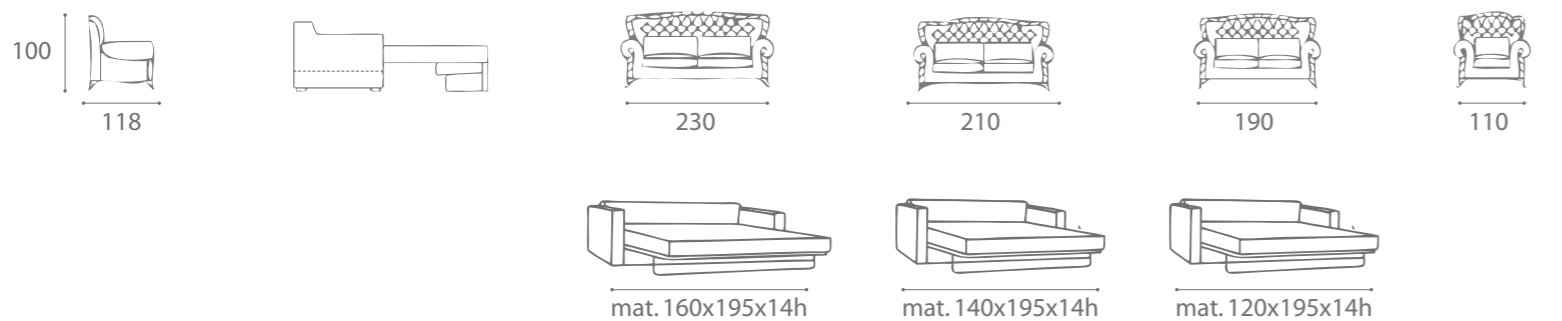

# BENTLEY

pag. 20/27

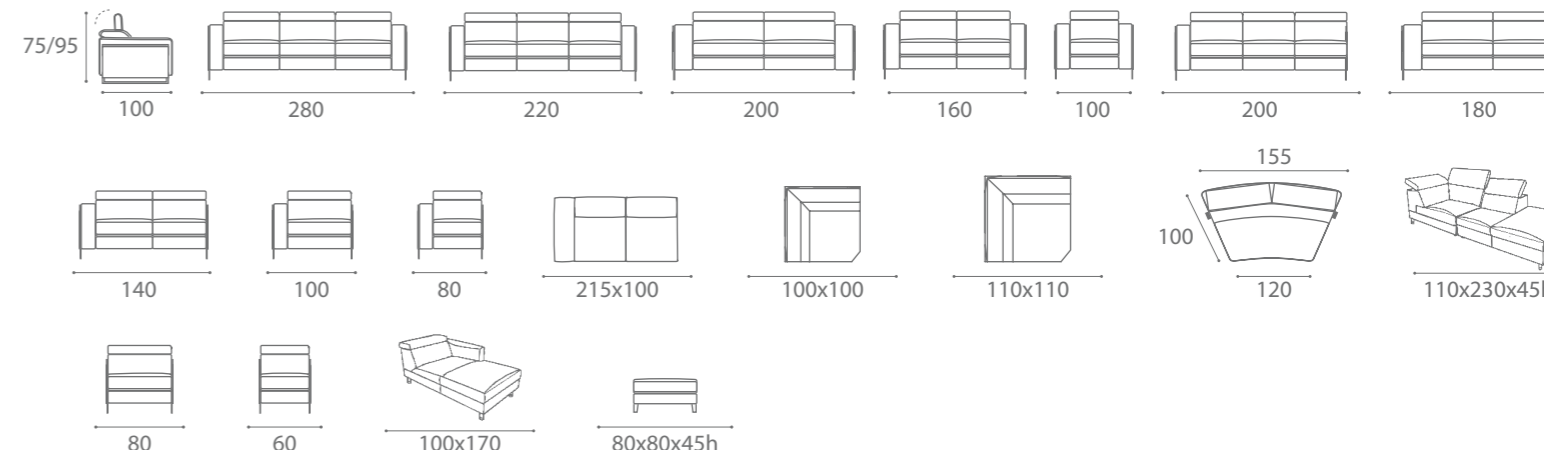





# BERGERÈ

pag. 156/159



# CONCORD

pag. 32/39

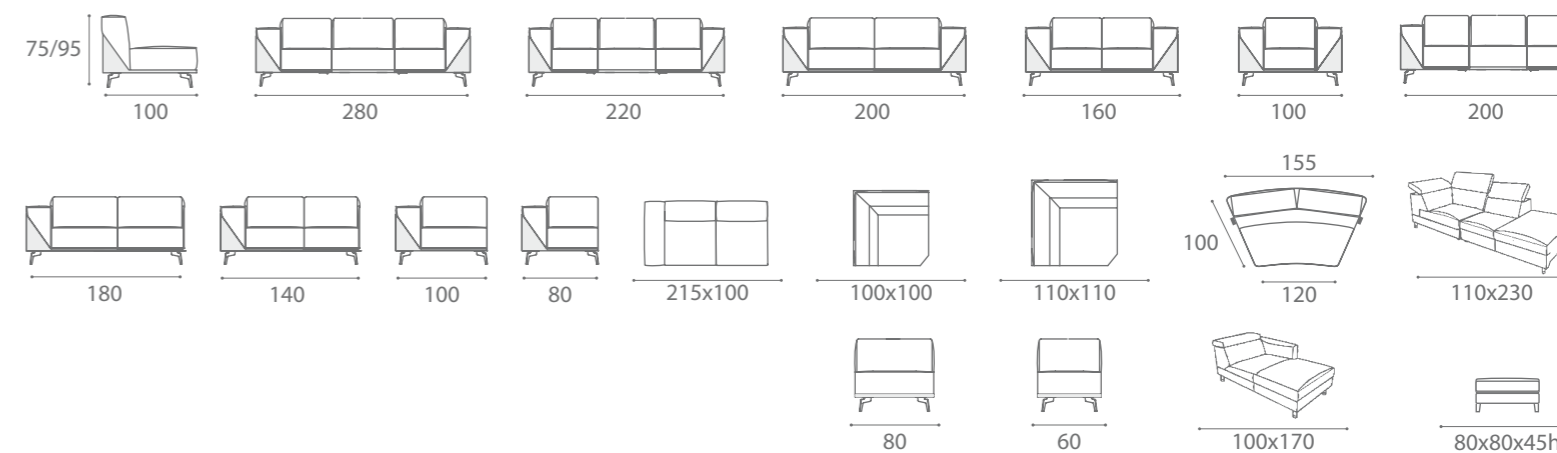

# BONUS

pag. 264/265

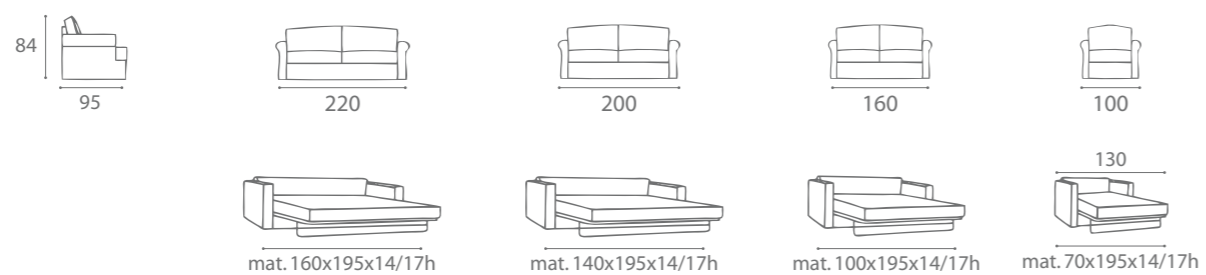

# DALÌ

pag. 214/215



# CIRO

pag. 256/259

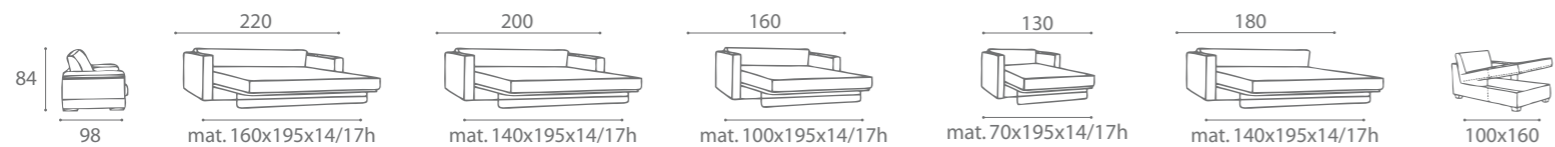

# DECOR

pag. 44/47

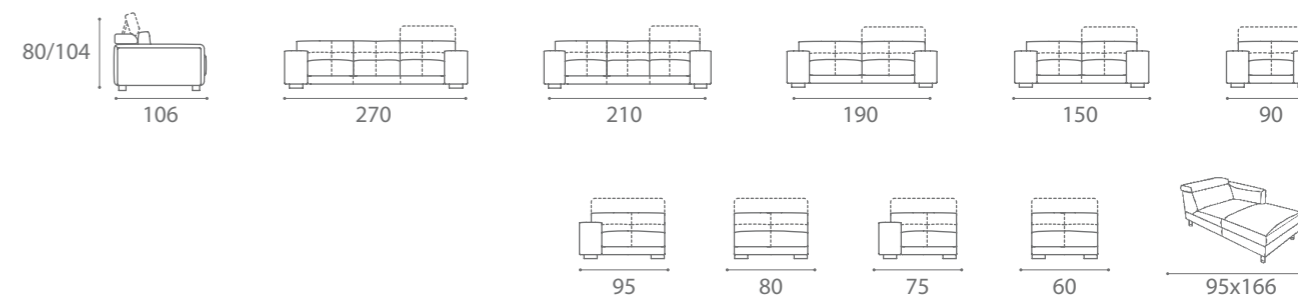



## DIVA pag. 150/151



## DRIADE pag. 58/59

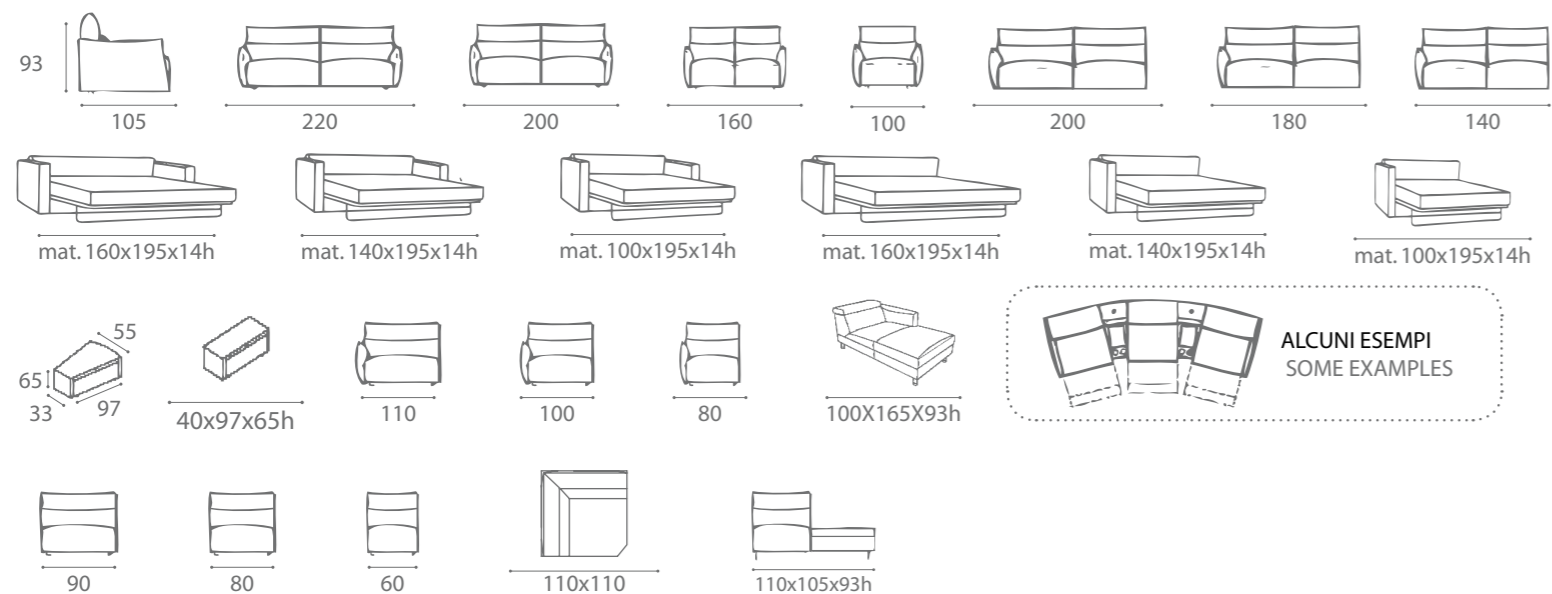

## ELITE pag. 192/195

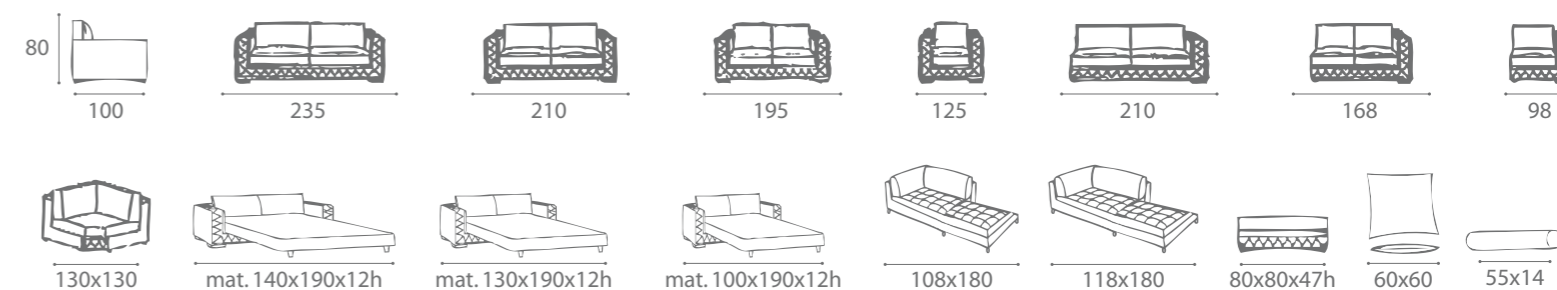

## EMPORIO pag. 196/199



## DUSE pag. 218/219

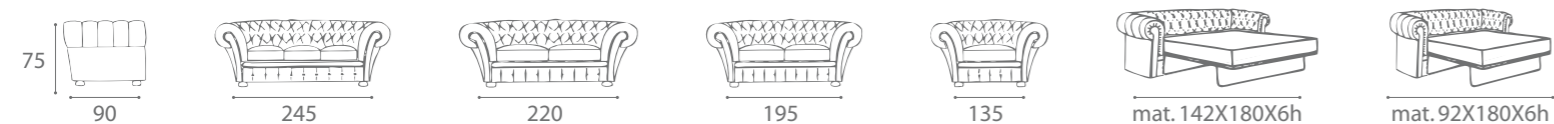

## FASHION pag. 124/129

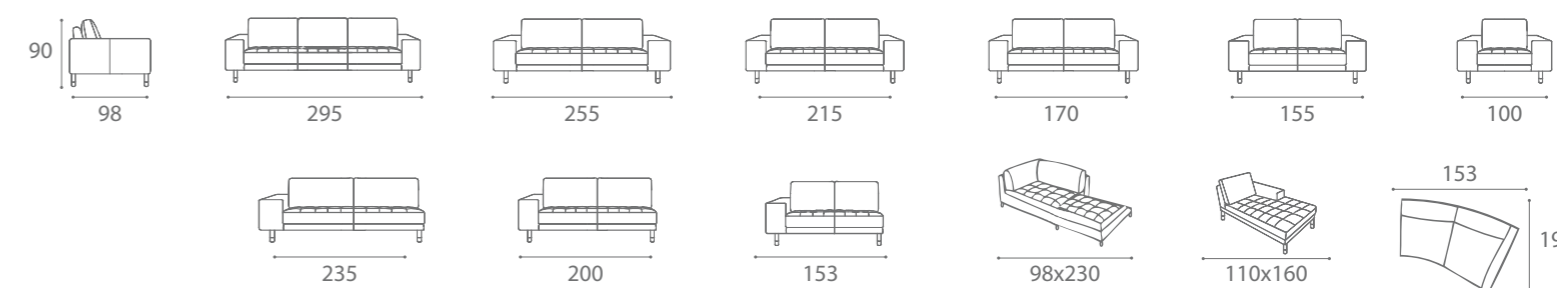



# FLOR

pag. 146/147

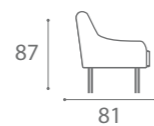

# GINGER

pag. 152/155

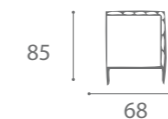

# GAMMA

pag. 40/43

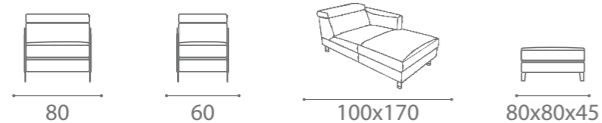
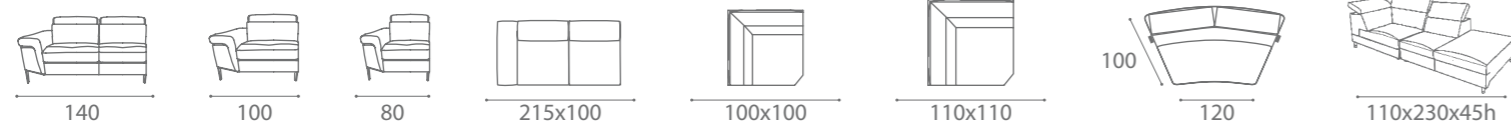
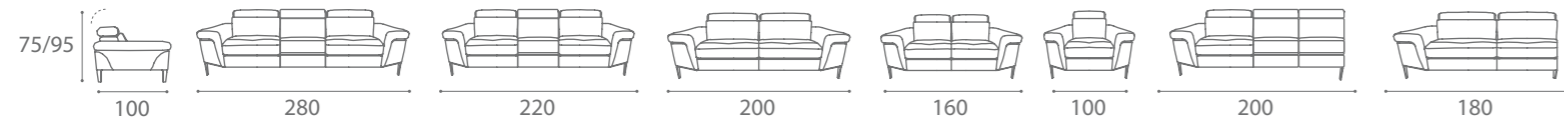

# HARRY

pag. 260/263

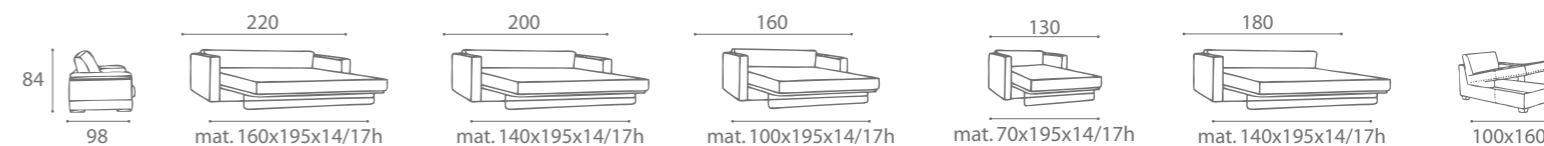

# GASSMAN

pag. 72/97

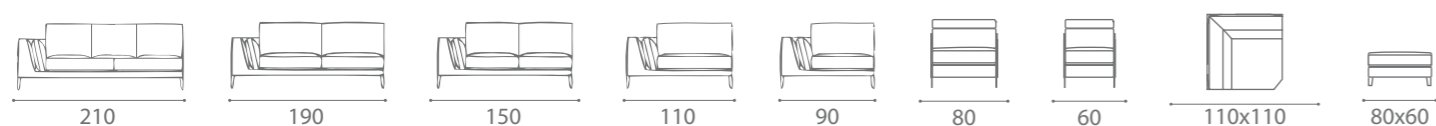
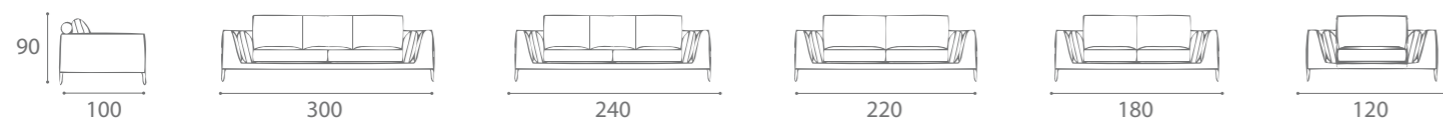

# HILTON

pag. 166/169

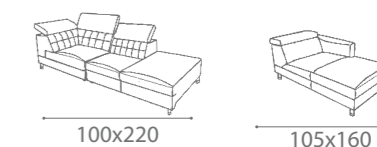



# INGRID

pag. 170/173

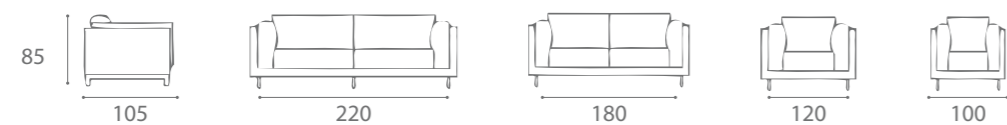

# LEVANTE

pag. 188/189



# KALLAS

pag. 142/145

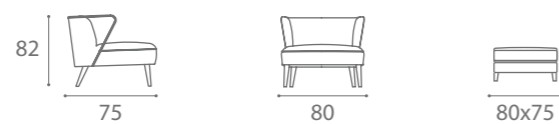

# LUGANO

pag. 116/119

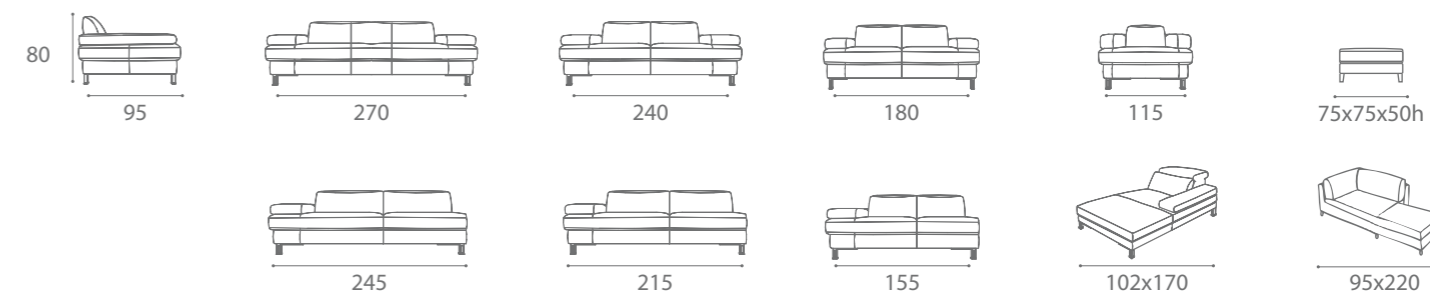

# KRIS

pag. 140/141

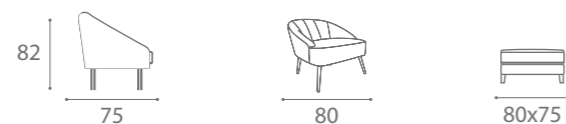

# LUPIN

pag. 182/183

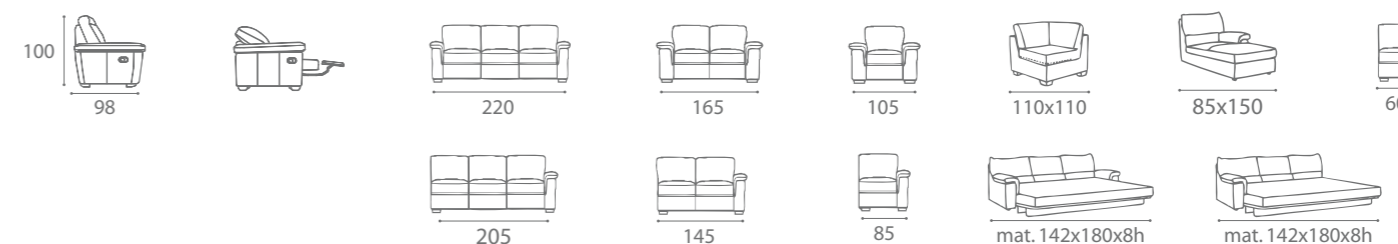



# LUXOR

pag. 204/207

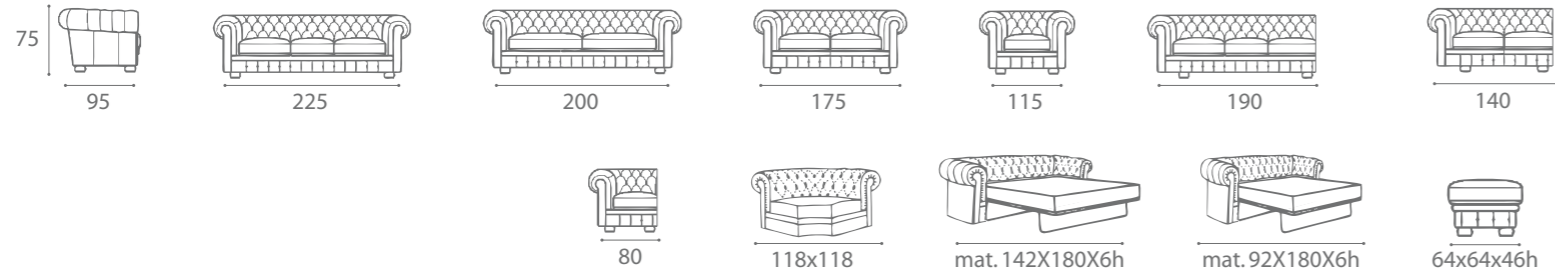

# MATRIX

pag. 28/31

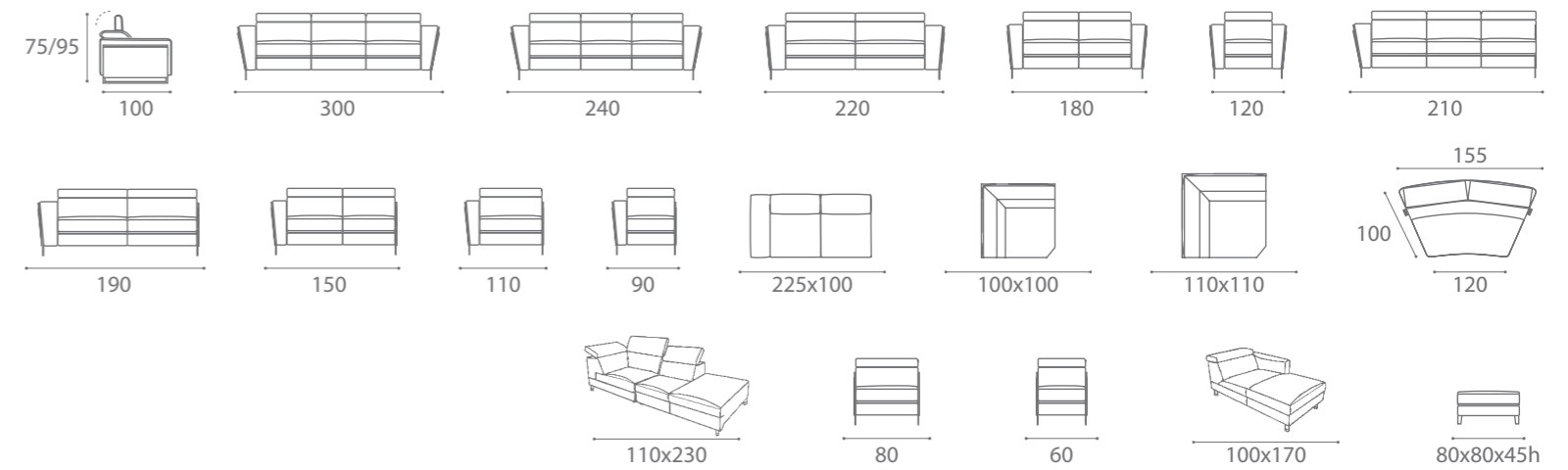

# LUXOR MINI

pag. 160/161 • pag. 208/209



# MEGAN

pag. 148/149

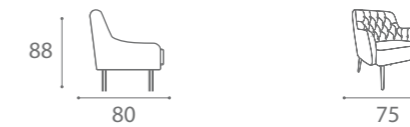

# MAGNUM

pag. 234/237

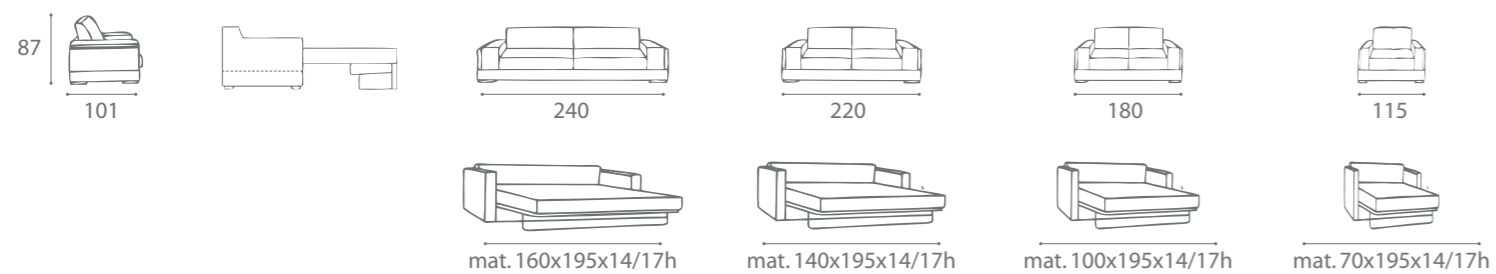

# MICHELA

pag. 178/181





# MONZA

pag. 108/113

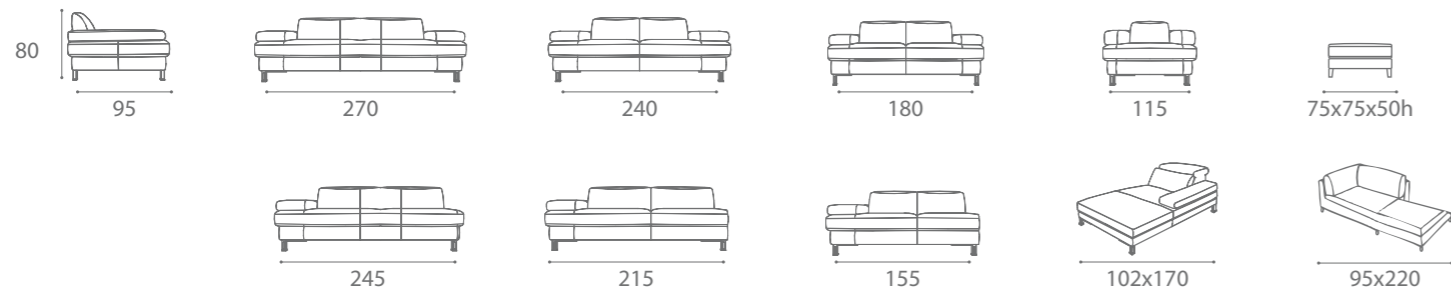

# OCEAN

pag. 80/87

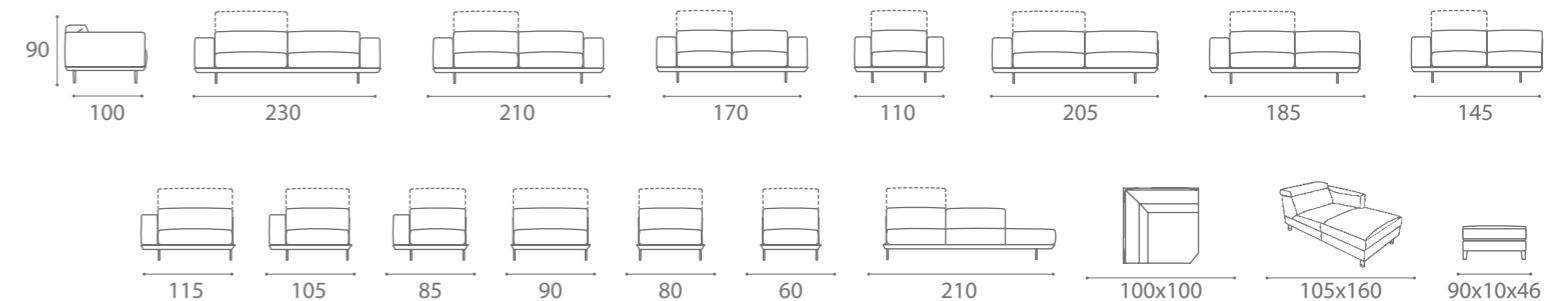

# NATHAN

pag. 88/93



# OLIVER

pag. 224/227

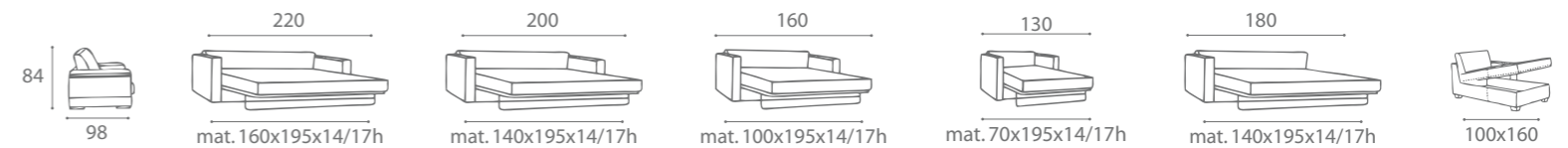

# NILOS

pag. 114/115

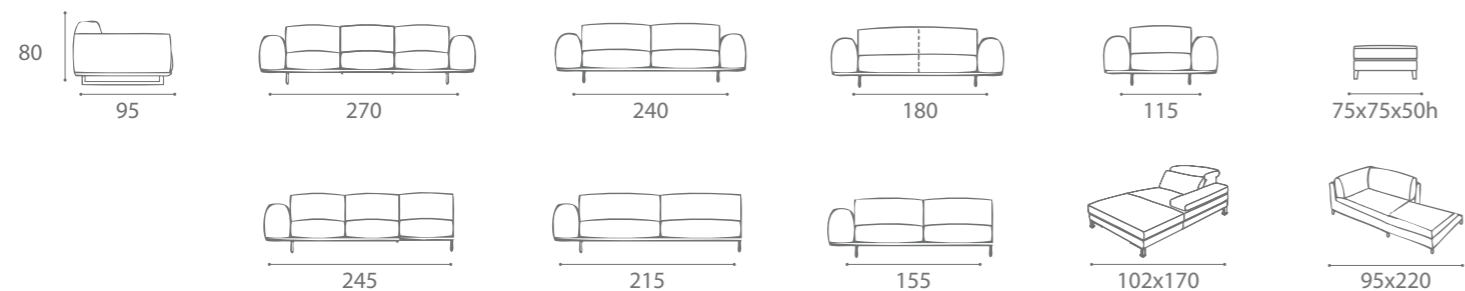

# ONDA

pag. 130/133

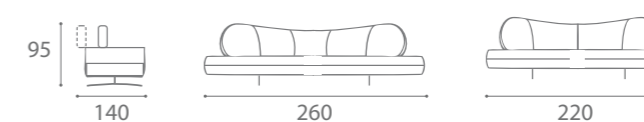



# PARIS pag. 16/19

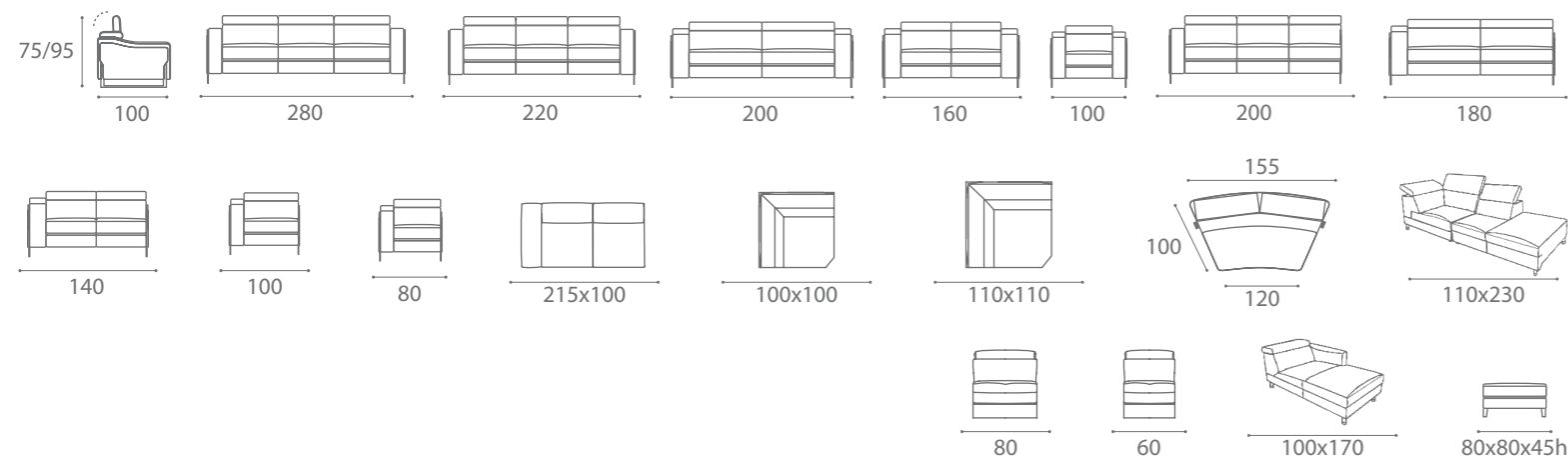

# PRISMA pag. 54/57

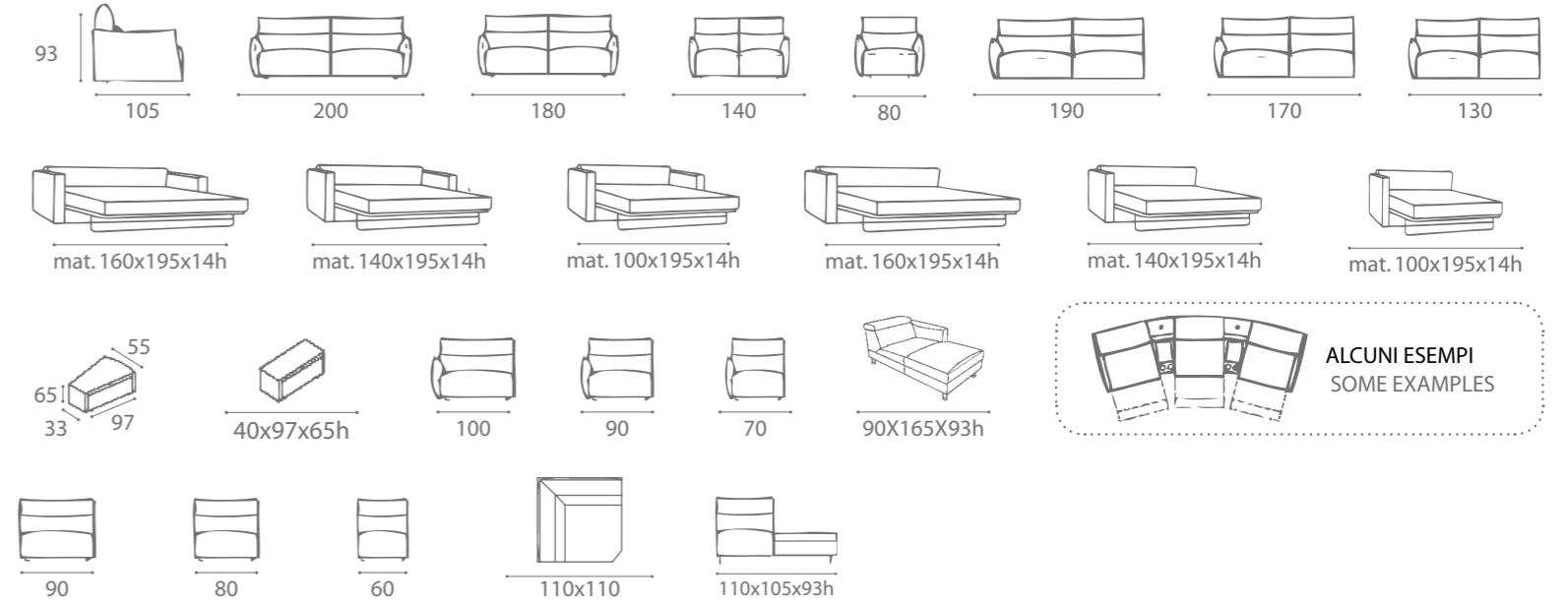

# PIXEL pag. 242/245

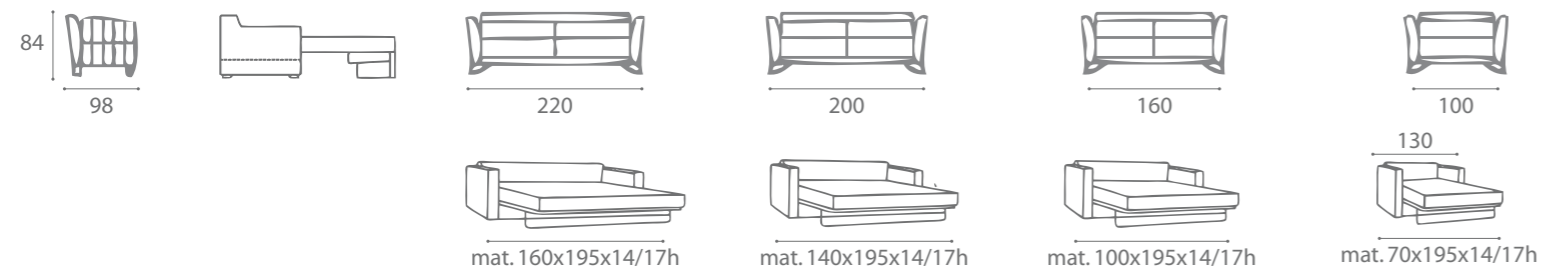

# QUADRO pag. 100/103

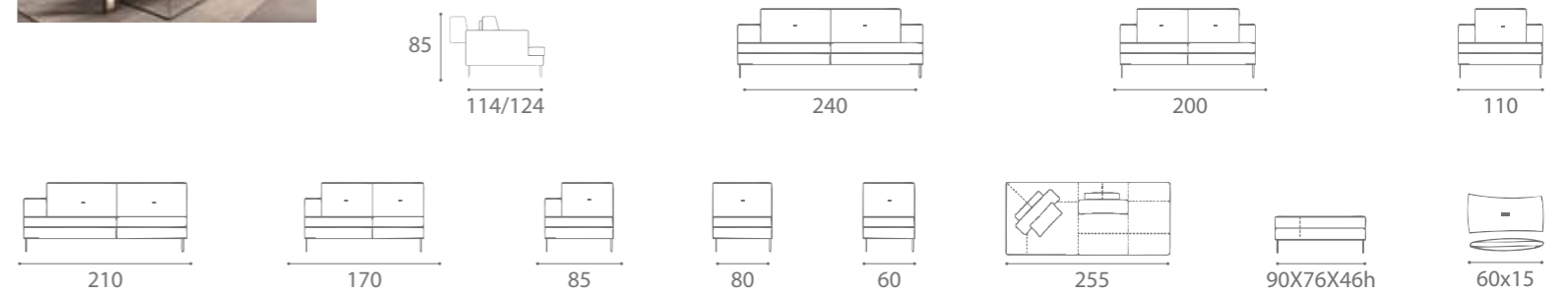

# PLAZA pag. 184/187

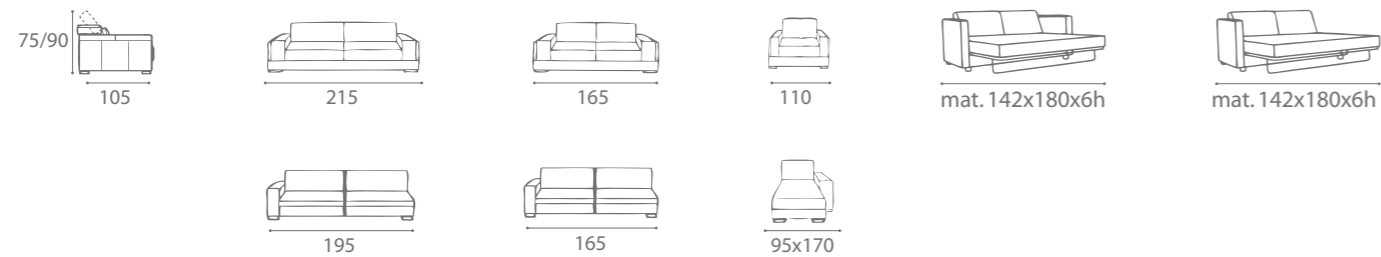

# QUIZ1 / 1 SLIM / 3 / 4 pag. 246/255

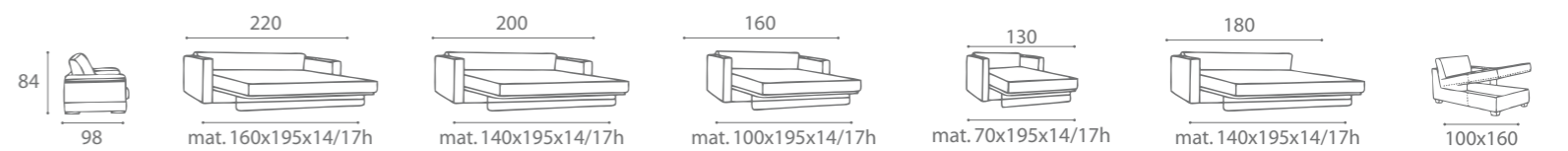



# ROYAL

pag. 220/221

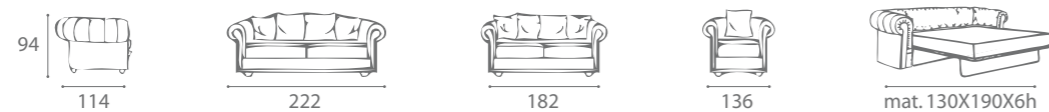

# SPARTA

pag. 174/177

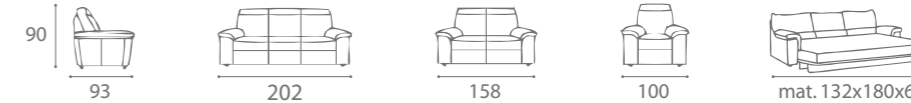

# RUSSEL

pag. 94/99

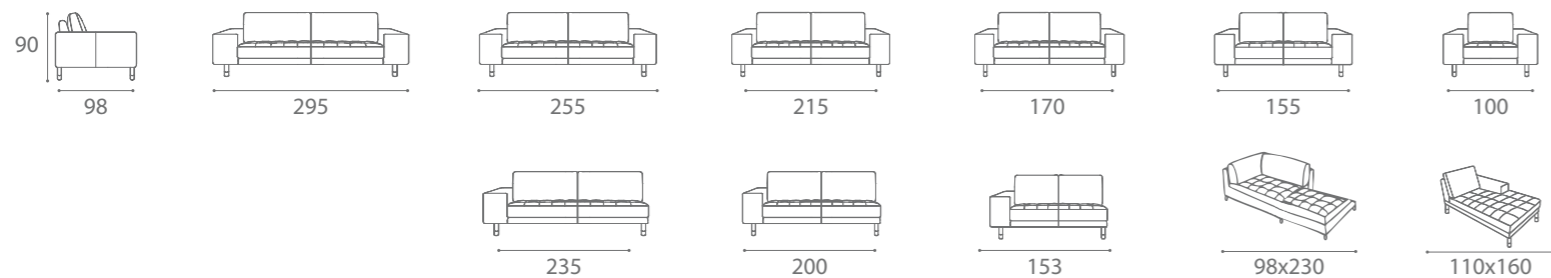

# SPIDER

pag. 238/241

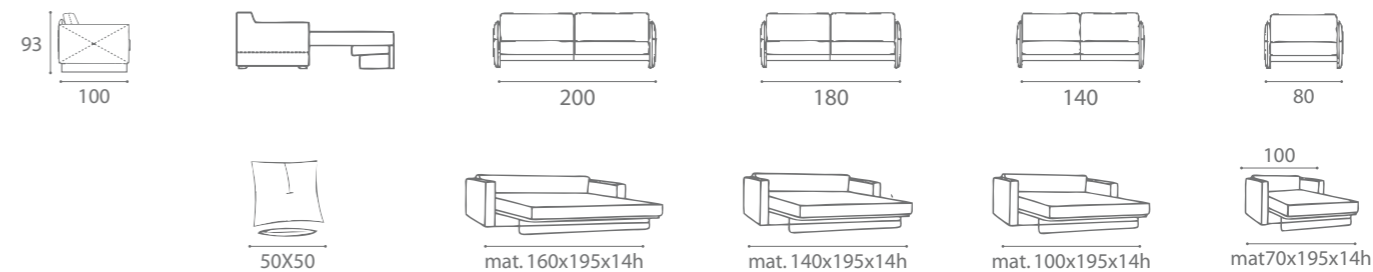

# SECRET

pag. 48/53

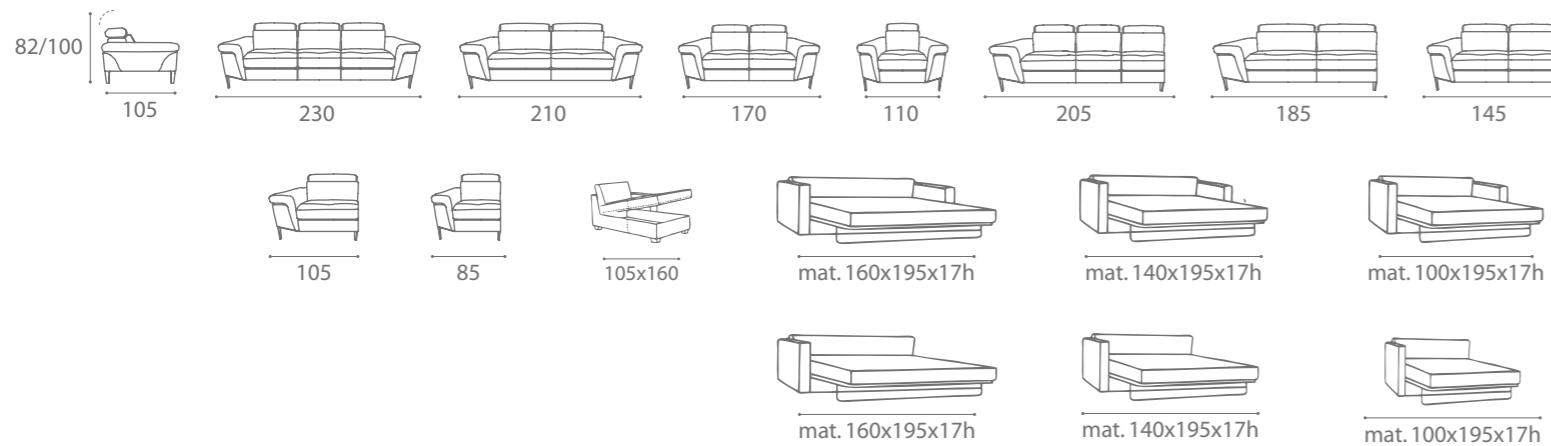

# TONIC

pag. 120/123

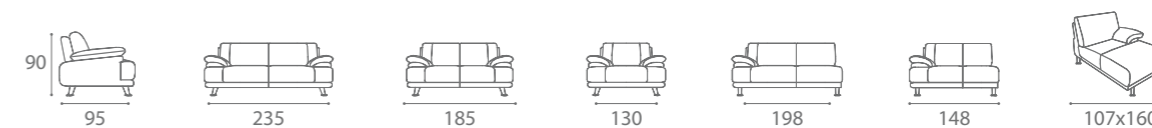





# TRILUSSA pag. 60/63

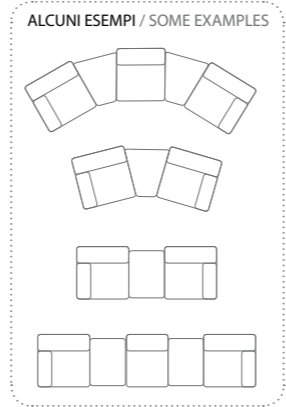
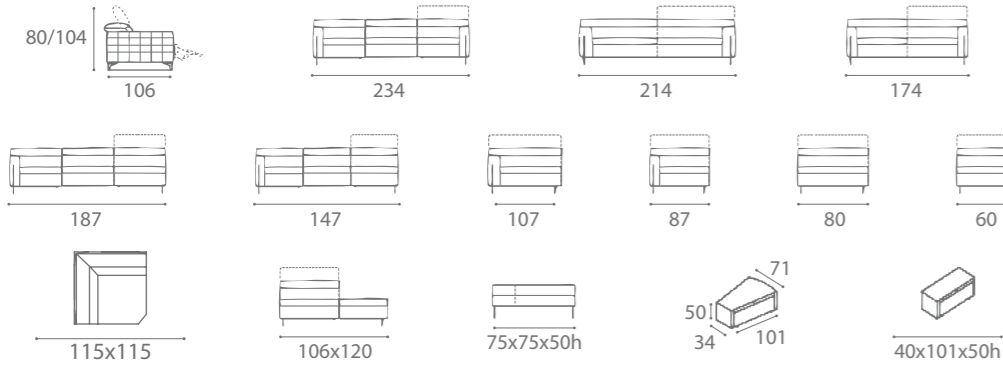

# VIP pag. 216/217

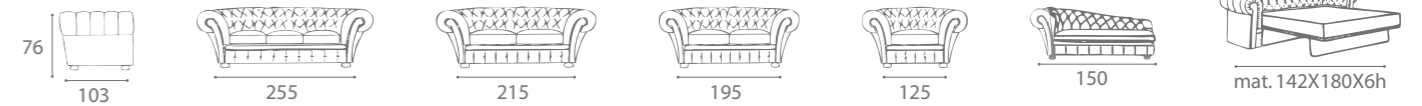

# TRILUSSA SLIM / LUX pag. 64/69

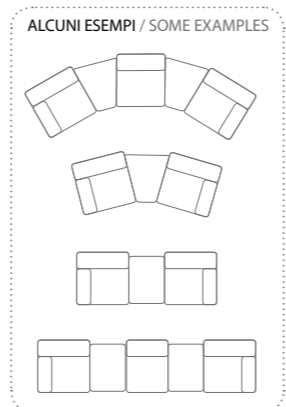
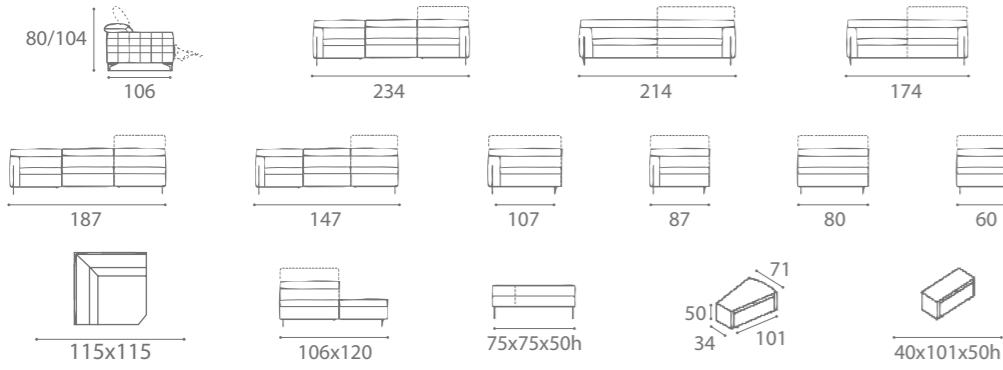

# VOGUE pag. 134/137

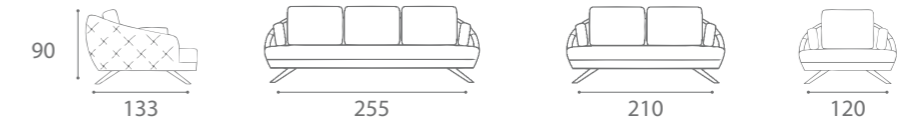

# VANITY pag. 200/203

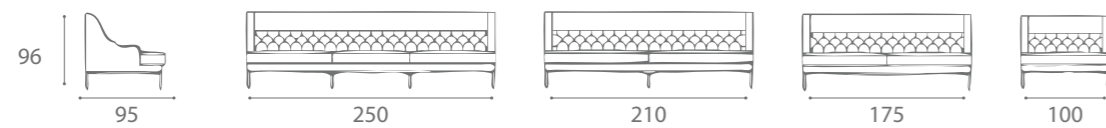

I colori dei tessuti, delle pelli e delle finiture in legno o metallo presenti in questo catalogo sono suscettibili dei processi di stampa: si prega di far riferimento al campionario dell'azienda. Tutti gli elementi di arredo (cuscinetti, poggiatesta, passamanerie etc) e le finiture dei piedini riportati negli scatti fotografici non sono da considerarsi di serie o parte integrante del modello ma devono essere richiesti ed ordinati separatamente.

L'azienda si riserva la facoltà di modificare in qualunque momento e senza preavviso le caratteristiche tecniche (misure, finiture, tessuti e pelli) dei suoi prodotti.

Fabric and leather colours, together with wooden and metal finishes, as showed in this catalogue, are not always reliable due to printing effects: simply refer to the company samples. All decorative elements (pillows, backrests, trimmings etc) and the legs finishes shown in the catalogue pictures are not to be considered as standard or integral part of the model but must be requested and ordered separately.

The company reserves the rights to modify the technical specifications of the products (size, finishing, leather and fabric) featured in at any time and without prior notice.

AGOSTO 2022

concept **FDESIGN** ITALIA  
photo STUDIOSET  
printed GRAFICA & STAMPA